

Explosietekeningen

In het nu volgende deel zijn de explosietekeningen van de machine opgenomen. De tekeningen met hun volledige details kunnen helpen de machine beter te leren kennen.

Onderkastgroep

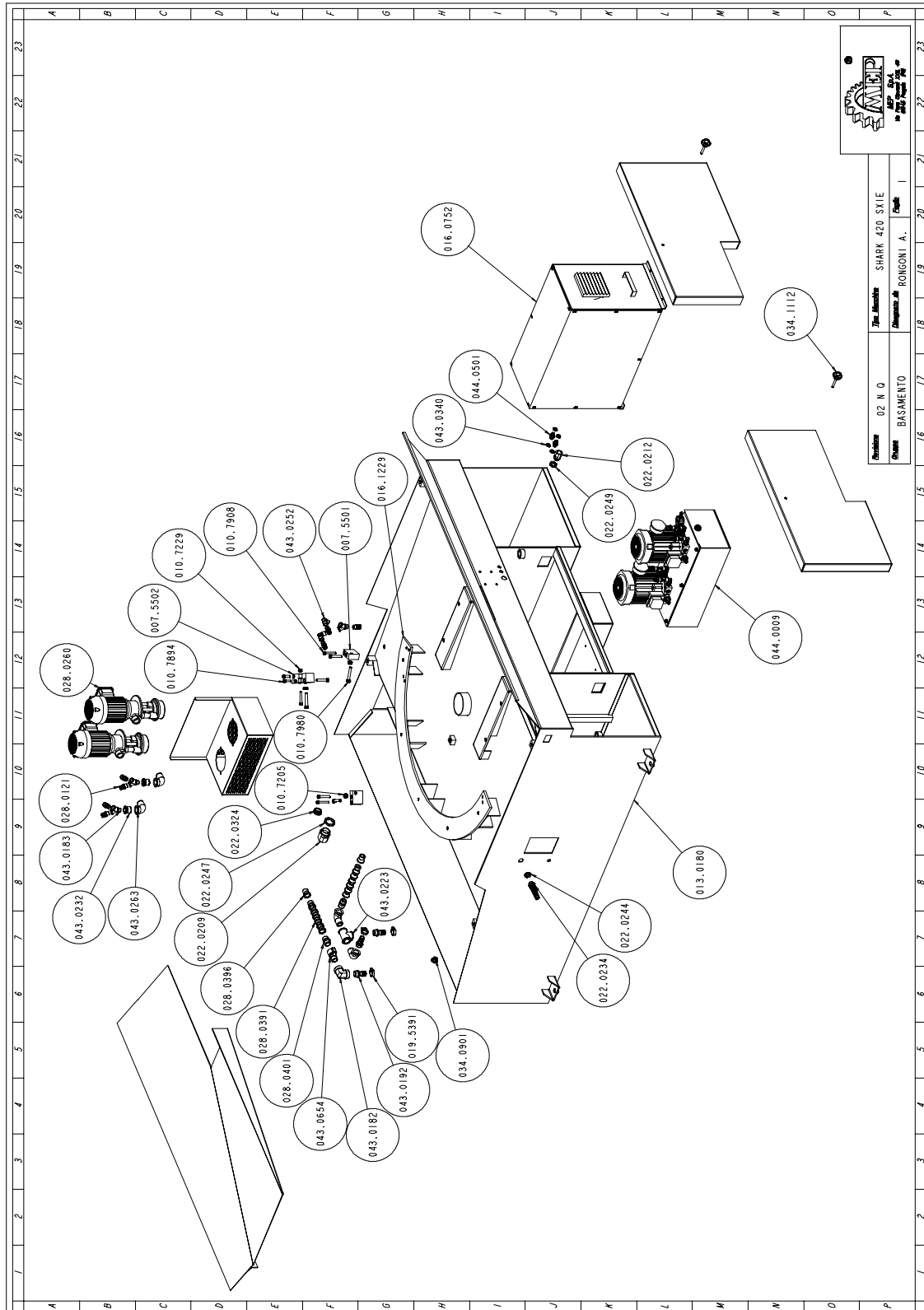

		SHARK 420 SX1E	
		Model	Code
02 H 0	BASSAMENTO	RONGONI A.	I

Art. NR.	Benaming	M.	Hoeveelheid
007.5501	TASSELLO X BATTUTA 45ØSX - 60ØDX	NR	2,000
007.5502	TASSELLO X BATTUTA 45Ø DX SH 420 SE	NR	1,000
010.1201	VITERIA E BULLONERIA	NR	7,000
010.7205	DADO M10	NR	3,000
010.7221	DADO M16 BASSO	NR	1,000
010.7229	DADO AUTOBLOCCANTE M8	NR	1,000
010.7603	RONDELLA DIAM. 6	NR	12,000
010.7868	VITE TCEI 6 X 12	NR	2,000
010.7870	VITE TCEI 6 X 16	NR	10,000
010.7894	VITE TCEI 8 X 25	NR	2,000
010.7908	VITE TCEI 8 X 50	NR	6,000
010.7980	VITE TE 10 X 60	NR	3,000
010.7995	VITE TSPEI 6 X 16	NR	5,000
013.0180	PIEDISTALLO SH 420 SE	NR	1,000
016.0752	QUADRO ELETTRICO SH 420 SE	NR	1,000
016.1229	PIASTRA DI ROTAZIONE SH 420 SE	NR	1,000
019.4006	MOTORE CENTRALINA HP 0,5 C71	NR	1,000
019.5117	COPRIVENTOLA	NR	1,000
019.5211	VENTOLA 4715MS 23TB	NR	1,000
019.5391	FASCETTA MINUS GT	NR	3,000
022.0209	RACCORDO RAPIDO SEM 29 ART.3800296	NR	1,000
022.0212	RACCORDO RAPIDO SEM PG 16	NR	1,000
022.0234	PRESSACORDONE 3246 NERO PG 13,5	NR	1,000
022.0244	CONTRODADO 3217B GRIGIO PG 13	NR	1,000
022.0247	DADO POLIAM.HUMMEL 1.262.2900.11	NR	1,000
022.0249	DADO POLIAM.HUMMEL 1.262.1600.11	NR	1,000
022.0324	PASSACAVI 24 INC.MM.2.5	NR	1,000
028.0121	RACCORDO 3/8-17 CL 2601	NR	7,000
028.0260	ELETTROPOMPA	NR	2,000
028.0391	TUBO LOOC LINE SPD FP50.10315 3/4	MT	2,000
028.0396	UGELLO 0 20 SPD FP50.11B50	NR	2,000
028.0401	RACCORDO 3/4 SPD FP50.17A20	NR	2,000
034.0414	COPERCHIO ALETT. A12C-7032	NR	1,000
034.0901	TAPPO LIVELLO OLIO 1/2 "GAS.	NR	3,000
034.0906	TAPPO OLIO CENTRALINA IDRAULICA	NR	2,000
034.1112	VOLANTINO DIAM.40 M8	NR	2,000
043.0182	RACCORDO A GOMITO FF ZINCATO 3/4	NR	1,000
043.0183	RACCORDO A Y 90Ø MASCHIO 3/8	NR	3,000
043.0192	RACCORDO RB 9889 3/4X20	NR	3,000
043.0219	RACCORDO A" T" MFF 1/4" CL-2070	NR	2,000
043.0223	RACCORDO TE FFF ZINCATO 3/4	NR	1,000
043.0232	RIDUZIONE ZINCATA 3/4	NR	2,000
043.0252	GOMITO MF 3/8 CL 2020	NR	2,000
043.0260	TAPPO TTE4 1/4 - CL 2611	NR	3,000
043.0263	RACCORDO A GOMITO M/F ZINCATO 3/4	NR	4,000
043.0290	INNESTO RAPIDO 1/4 GHIOTTO 13/A	NR	1,000
043.0340	RONDELLA RAME 13X19X1,5-1/4	NR	4,000
043.0349	GUARNIZIONE GFV 1/8	NR	1,000
043.0350	GUARNIZIONE GFV 1/4	NR	9,000
043.0654	RUBINETTO M/F 3/4 CL 6310	NR	1,000
044.0009	.CENTRALINA IDRAULICA COMPLETA	NR	1,000
044.0020	MONOCENTRALINA CC 2,2 GR 0,5 MOT.80	NR	1,000
044.0501	NIPPLO NP 1/4 IDRAULICO	NR	7,000
044.0650	PROLUNGA 1/4 MF ES.36 MM.	NR	1,000
044.1253	VALVOLA DI MASSIMA	NR	2,000
044.4502	POMPA IDRAULICA X MONOCENTRALINA	NR	1,000
044.5121	COLLETTORE CENTRALINA CON POMPA	NR	1,000

Vaste-tafel groep

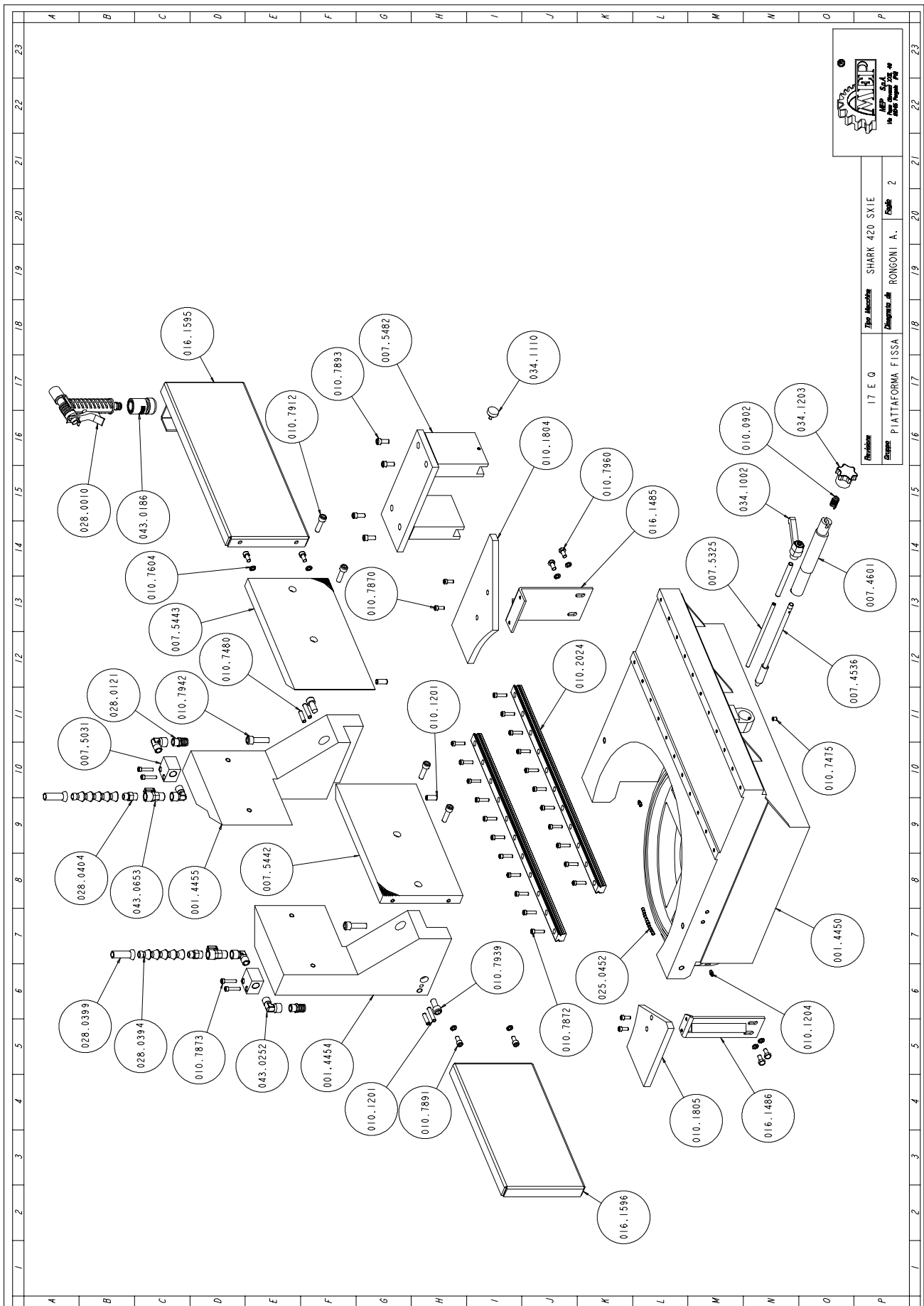

Art. NR.	Benaming	M.	Hoeveelheid
001.4450	PIATTAFORMA FISSA	NR	1,000
001.4454	SQUADRO MORSA SINISTRO	NR	1,000
001.4455	SQUADRO MORSA DESTRO	NR	1,000
007.4536	PERNO PUNTO FISSO	NR	1,000
007.4601	CILINDRETTO PUNTO FISSO	NR	1,000
007.5031	SQUADRETTO X LIQUIDO PIANO GIREVOLE	NR	2,000
007.5325	PERNO X BLOCCAGGIO PIANO GIREVOLE	NR	1,000
007.5442	GANASCIA FISSA SINISTRA SH 420 SE	NR	1,000
007.5443	GANASCIA FISSA DESTRA	NR	1,000
007.5482	PIANO APPOGGIA BARRA SUPPLEMENTARE	NR	1,000
010.0902	MOLLE PUNTO FISSO TESTA	NR	1,000
010.1201	VITERIA E BULLONERIA	NR	4,000
010.1204	INGRASSATORE M 6	NR	2,000
010.1804	CHIUSURA X RULLIERA DESTRA SH 420SE	NR	1,000
010.1805	CHIUSURA X RULLIERA SINISTRA SH 420	NR	1,000
010.2024	GUIDA PATTINO LGR 25-R0640-C	NR	2,000
010.7475	GRANO VCE P.PIANA 8 X 8	NR	1,000
010.7480	GRANO VCE PUNTA PIANA 8 X 30	NR	2,000
010.7604	RONDELLA DIAM. 8	NR	8,000
010.7870	VITE TCEI 6 X 16	NR	4,000
010.7872	VITE TCEI 6 X 25	NR	22,000
010.7873	VITE TCEI 6 X 30	NR	4,000
010.7891	VITE TCEI 8 X 16	NR	4,000
010.7893	VITE TCEI 8 X 20	NR	4,000
010.7912	VITE TCEI 10 X 35	NR	4,000
010.7939	VITE TCEI 12 X 25	NR	2,000
010.7942	VITE TCEI 12 X 40	NR	2,000
010.7960	VITE TE 8 X 16	NR	4,000
016.1485	STAFFA FISSAGGIO CHIUSURA RULLIERA	NR	1,000
016.1486	STAFFA FISSAGGIO CHIUSURA RULLIERA	NR	1,000
016.1595	PROLUNGA GANASCIA DESTRA SH 420 SE	NR	1,000
016.1596	PROLUNGA GANASCIA SINISTRA SH 420SE	NR	1,000
025.0452	RULLI 6X6 AISI 420	NR	41,000
028.0010	PISTOLA	NR	1,000
028.0121	RACCORDO 3/8-17 CL 2601	NR	2,000
028.0394	TUBO LOOC LINE 1/2	MT	0,600
028.0399	UGELLO 0 12/7	NR	2,000
028.0404	RACCORDO 1/2	NR	2,000
034.1002	LEVA A SCATTO 10 MA	NR	1,000
034.1110	VOLANTINO DIAM.30 M6 X 10	NR	1,000
034.1203	IMPUGNATURA NS. DISEGNO M10	NR	1,000
043.0186	RACCORDO FEMMINA 1/2 AQUASTOP	NR	1,000
043.0252	GOMITO MF 3/8 CL 2020	NR	4,000
043.0653	RUBINETTO M/F 3/8 CL 6310	NR	2,000

Draaiplateaugroep

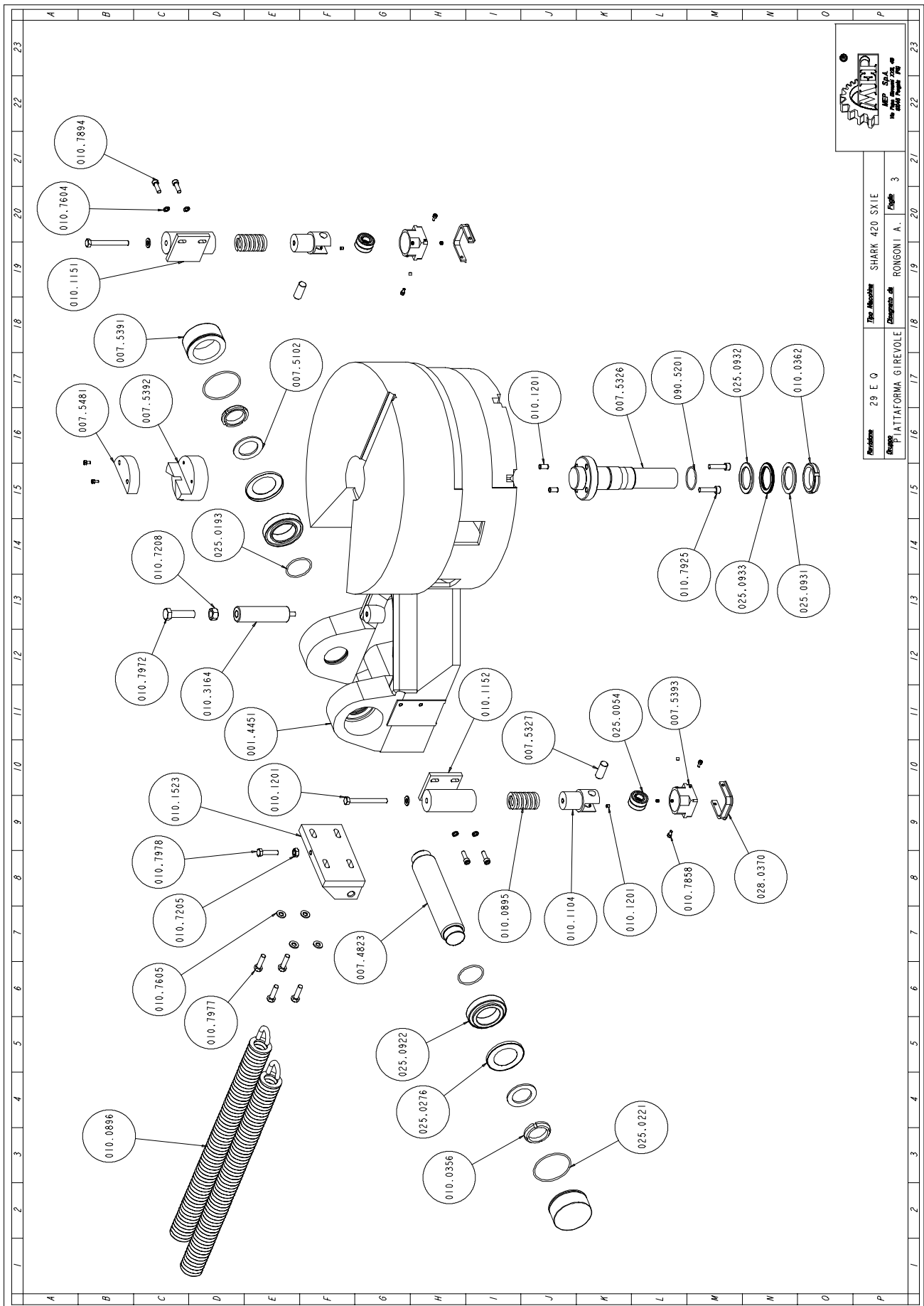

Revisie	29 E 0	Deel	SHARK 420 SX/E
Geplaatst		Ontwerper	RONSONI A.
		Bladzijde	3

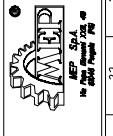

Art. NR.	Benaming	M.	Hoeveelheid
001.4451	PIATTAFORMA ROTANTE	NR	1,000
007.4823	PERNO SNODO ARCHETTO	NR	1,000
007.5102	DISTANZIALE CUSCINETTO SNODO ARCHET	NR	2,000
007.5326	PERNO DI CENTRO SH 420 SE	NR	1,000
007.5327	PERNO X CUSCINETTO AMMORTIZZATORE	NR	2,000
007.5391	BUSSOLA PERNO SNODO TESTA SH 420 SE	NR	2,000
007.5392	BUSSOLA X GANASCE SQUADRI MORSA	NR	1,000
007.5393	BUSSOLA RASCHIAPOLVERE SH 420 SE	NR	2,000
007.5481	PIASTRA DI TAGLIO SH 420 SE	NR	1,000
010.0356	GHIERA AUTOBLOCCANTE 45X1,5	NR	2,000
010.0362	GHIERA DI PRECISIONE 50X1,5 PRT	NR	1,000
010.0895	MOLLA AMMORTIZZATORI SH 420 SE	NR	2,000
010.0896	MOLLA RICHIAMO TESTA	NR	2,000
010.1104	FORCELLA X CUSCINETTI SH 420 SE	NR	2,000
010.1151	AMMORTIZZATORE DESTRO SH 420 SE	NR	1,000
010.1152	AMMORTIZZATORE SINISTRO SH 420 SE	NR	1,000
010.1201	VITERIA E BULLONERIA	NR	10,000
010.1523	STAFFA AGG.DOPPIA MOLLA PIATT.FISSA	NR	1,000
010.3164	BATTUTA FINECORSO TESTA	NR	1,000
010.7205	DADO M10	NR	1,000
010.7208	DADO M16	NR	1,000
010.7604	RONDELLA DIAM. 8	NR	4,000
010.7605	RONDELLA DIAM. 10	NR	6,000
010.7858	VITE TCEI 5 X 10	NR	6,000
010.7894	VITE TCEI 8 X 25	NR	4,000
010.7925	VITE TCEI 10 X 40	NR	2,000
010.7972	VITE TE 16X60	NR	1,000
010.7977	VITE TE 10 X 35	NR	4,000
010.7978	VITE TE 10 X 40	NR	1,000
025.0054	CUSCINETTO 62.03 2Z	NR	4,000
025.0193	ANELLO DI TENUTA OR 158	NR	2,000
025.0221	ANELLO OR 176	NR	2,000
025.0276	ANELLO DI PROTEZIONE NILOS 32011	NR	2,000
025.0246	ANELLO DI DI TENUTA POLYPAC OR3187	NR	1,000
025.0922	CUSCINETTO 32011	NR	2,000
025.0931	RALLA GS 81110	NR	1,000
025.0932	RALLA WS 81110	NR	1,000
025.0933	GABBIA ASSIALE K81110	NR	1,000
028.0370	BARRETTA VULCANIZZATA TIPO VAJ A1	MT	2,000

Optional: gemotoriseerde draaiplaatgroep

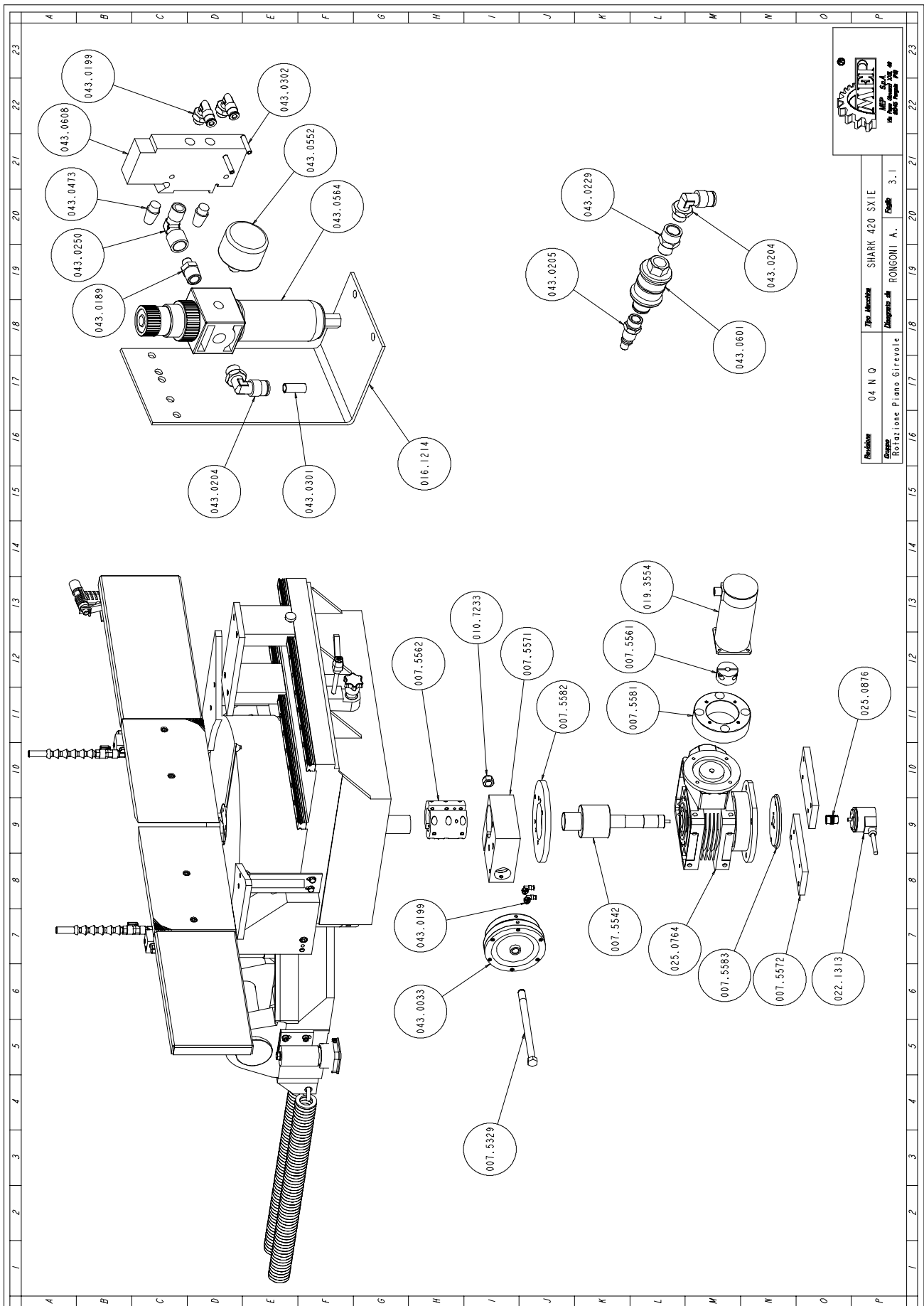

Revisione	04 N O	Tipo Macchine	SHARK 420 SXIE
Descrizione	Rotazione Placca Giradischi	Componente di	RONGONI A.
		Edizione	3.1

Art. NR.	Benaming	M.	Hoeveelheid
007.5329	PERNO VOLAMPRESS SH 420 SXI E	NR	1,000
007.5542	ALBERO RIDUTTORE SH 420 SXI E	NR	1,000
007.5561	GIUNTO X MOTORE P/P SH 420 SXI E	NR	1,000
007.5562	GIUNTO PERNO SH 420 SXI E	NR	1,000
007.5571	STAFFA BLOCCAGGIO ALBERO DI	NR	1,000
007.5572	STAFFA SUPPORTO RIDUTTORE SH	NR	2,000
007.5581	FLANGIA MOTORE P/P SH 420 SXI E	NR	1,000
007.5582	FLANGIA FISSAGGIO VOLAMPRESS	NR	1,000
007.5583	FLANGIA FISSAGGIO ENCODER SH 420SXI	NR	1,000
010.7233	DADO AUTOBLOCCANTE M16	NR	1,000
016.1214	PIASTRINO FIX. FR+L 1/4	NR	1,000
019.3554	MOTORE SM 88.4.18 M6 SN.19685 ROTA-	NR	1,000
022.1313	ENCODER CA 6S 4096 SSI GRAY 14 BIT	NR	1,000
025.0764	RIDUTTORE WR 75 UFI D30 240 P63 B5	NR	1,000
025.0876	GIUNTO WA 6-6 MM.28 X CILINDRO	NR	1,000
043.0033	CILINDRO VOLAMPRESS 125-8	NR	1,000
043.0189	RIDUZIONE 1/4-1/8 CL 2510 M/M	NR	1,000
043.0199	ATTACCO A GOMITO GIREV.4X1/8 CL6521	NR	2,000
043.0204	ATTACCO A GOMITO 8X1/4 - CL 6521	NR	2,000
043.0205	ATTACCO A ESAGONO 8X1/4 - CL 6510	NR	1,000
043.0229	RIDUZIONE MF 1/4 - CL 2520	NR	2,000
043.0250	GOMITO M.F. 1/4 CL 2020	NR	3,000
043.0301	TUBO RILSAN 8X6 NERO COD.17257181	MT	1,000
043.0302	TUBO RILSAN 4X2.7 BIANCO C.17257162	MT	2,000
043.0473	SILENZIATORE IN OTTONE 1/8" CL 2921	NR	2,000
043.0552	MANOMETRO DIAM. 40	NR	1,000
043.0564	FR 1/4 20-08	NR	1,000
043.0601	VALVOLA VMS 114-1/4 08	NR	1,000
043.0608	VALVOLA 5 VIE 1/8 PVLB111618 PARKER	NR	1,000

Klem groep

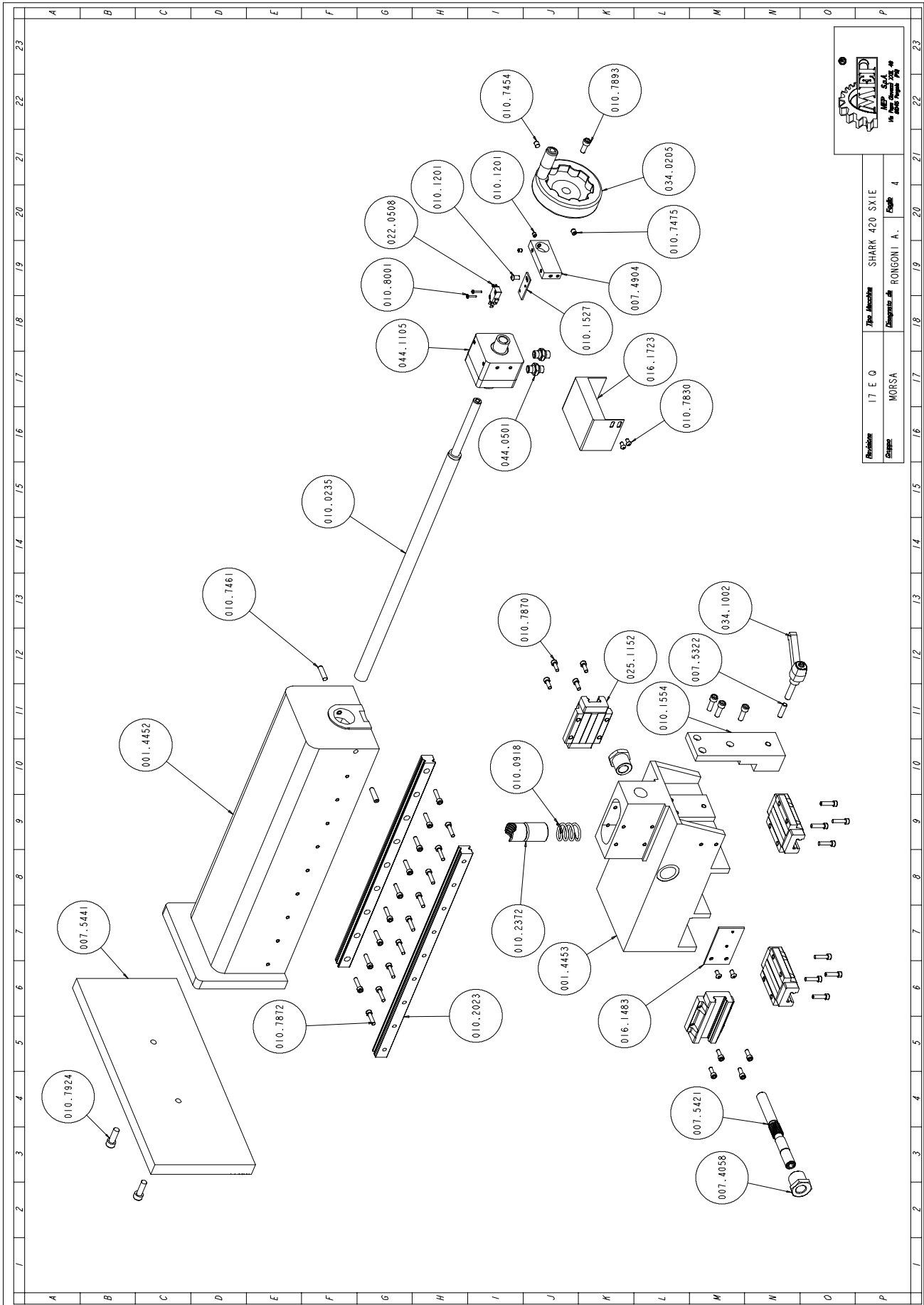

Art. NR.	Benaming	M.	Kvantum
001.4452	SCORREVOLE MORSA	NR	1,000
001.4453	SUPPORTO SCORREVOLE MORSA	NR	1,000
007.4058	BOCCOLA ECCENTRICA	NR	2,000
007.4904	SUPPORTO FINECORSO ALIMENTATORE	NR	1,000
007.5322	PERNO PER STAFFA BLOCCAGGIO MORSA	NR	1,000
007.5421	PIGNONE SBLOCCAGGIO SCORREVOLE SH	NR	1,000
007.5441	GANASCIA MORSA MOBILE SH 420 SE	NR	1,000
010.0235	VITE MORSA 685X24 SH 420 SE	NR	1,000
010.0918	MOLLA RICHIAMO CHIOCC.VITE MORSA	NR	1,000
010.1201	VITERIA E BULLONERIA	NR	5,000
010.1527	STAFFA FIX F.C.PRESENZA BARRA	NR	1,000
010.1554	STAFFA BLOCCAGGIO MORSA DI TAGLIO	NR	1,000
010.2023	GUIDA PATTINO LGR 25-R0520-C	NR	2,000
010.2372	CHIOCCIOLA BRONZO 45Ø	NR	1,000
010.7413	GRANO VCE P.CIL. 8 X 30	NR	2,000
010.7454	GRANO VCE P.CON. 8 X 8	NR	1,000
010.7461	GRANO VCE PUNTA PIANA 6 X 25	NR	2,000
010.7475	GRANO VCE P.PIANA 8 X 8	NR	1,000
010.7491	GRANO VCE PUNTA PIANA 10 X 60	NR	1,000
010.7830	VITE BUTON 5 X 10	NR	2,000
010.7859	VITE TCEI 5 X 12	NR	4,000
010.7870	VITE TCEI 6 X 16	NR	8,000
010.7872	VITE TCEI 6 X 25	NR	26,000
010.7893	VITE TCEI 8 X 20	NR	1,000
010.7894	VITE TCEI 8 X 25	NR	7,000
010.7924	VITE TCEI 10 X 30	NR	2,000
016.1723	PROTEZIONE FINECORSO PRESENZA BARRA	NR	1,000
016.1483	STAFFA FISSAGGIO CATENA	NR	1,000
022.0508	FINECORSO V5B010 CB1	NR	1,000
025.0203	ANELLO TENUTA 35X25X7	NR	2,000
025.0452	RULLI 6X6 AISI 420	NR	1,000
025.1152	PATTINO LGW25HCZ3C	NR	4,000
034.0205	VOLANTINO VPRA/125 MR	NR	1,000
034.1002	LEVA A SCATTO 10 MA	NR	1,000
044.0501	NIPPLO NP 1/4 IDRAULICO	NR	2,000
044.1105	CILINDRO VOLAMPRESS D.E. SH 400	NR	1,000
090.5201	PARTICOLARI	NR	2,000

Doorsnede-aandrijf wiel groep

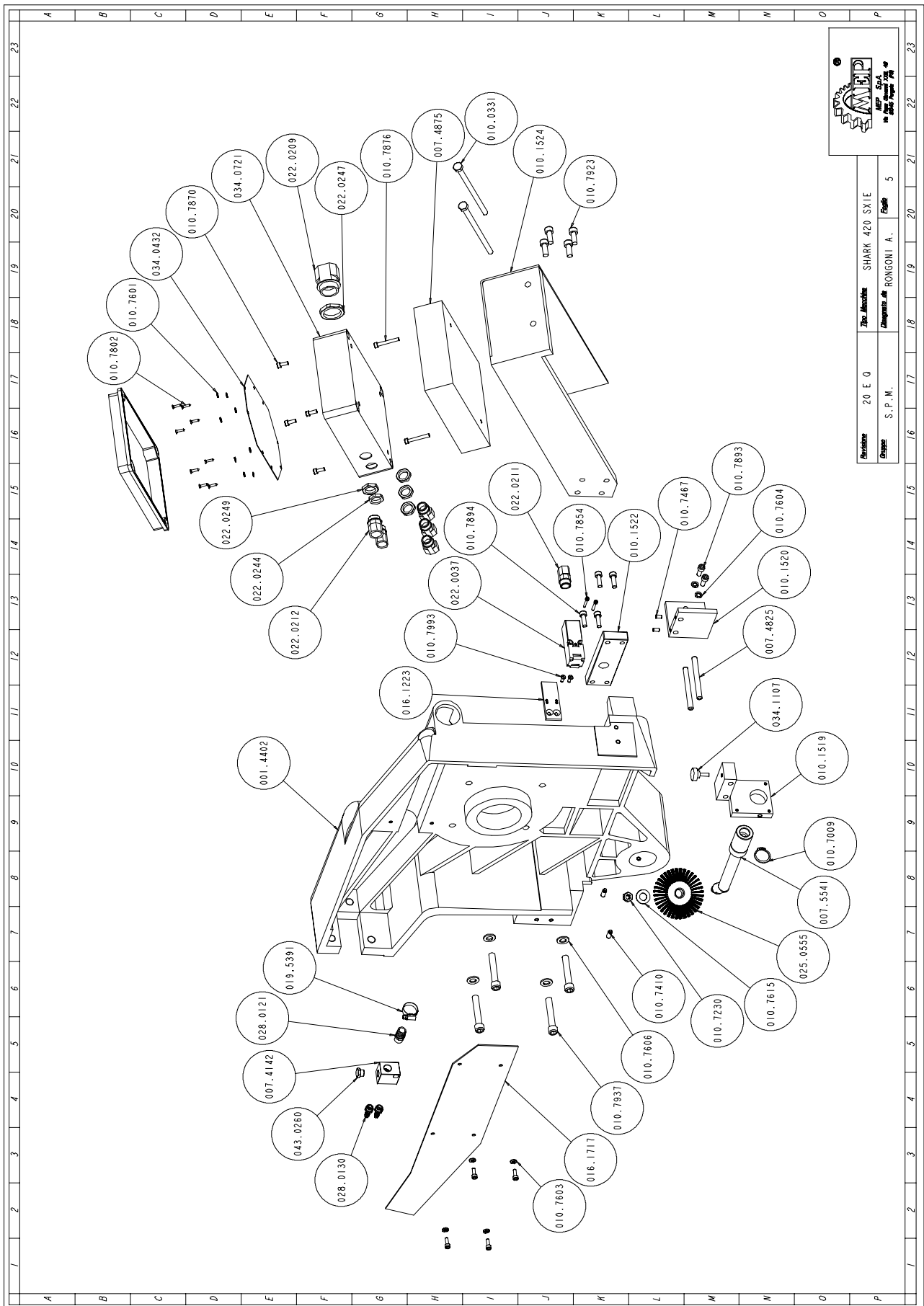

Art. NR.	Benaming	M.	Hoeveelheid
001.4402	ARCHETTO SEZIONE PULEGGIA MOTRICE	NR	1,000
007.4142	SQUADRETTO PER LIQUIDO	NR	1,000
007.4825	PERNO DI SCORRIMENTO X MOTORE	NR	2,000
007.4875	PIASTRA BILANCIATRICE	NR	1,000
007.5541	ALBERO PORTASPAZZOLA PULILAMA	NR	1,000
010.1519	STAFFA FISS.MOTORE SPAZZOLA PULIL.	NR	1,000
010.1520	STAFFA REGOL.SPAZZOLA MOTORIZZATA	NR	1,000
010.1522	STAFFA ESTERNA CILINDRO	NR	1,000
010.1524	STAFFA AGG.DOPPIA MOLLA ARCHETTO	NR	1,000
010.7009	ANELLO SEEGER DIAM. 30	NR	1,000
010.7230	DADO AUTOBLOCCANTE M10	NR	1,000
010.7410	GRANO VCE P.CIL. 8 X 16	NR	2,000
010.7467	GRANO VCE PUNTA PIANA 6 X 12	NR	2,000
010.7601	RONDELLA DIAM. 4	NR	8,000
010.7603	RONDELLA DIAM. 6	NR	4,000
010.7604	RONDELLA DIAM. 8	NR	2,000
010.7606	RONDELLA DIAM. 12	NR	5,000
010.7615	RONDELLA DIAM. 15	NR	1,000
010.7802	VITE AUTOFILETTANTE 3,9 X 16	NR	8,000
010.7854	VITE TCEI 4 X 25	NR	2,000
010.7870	VITE TCEI 6 X 16	NR	8,000
010.7876	VITE TCEI 6 X 45	NR	2,000
010.7893	VITE TCEI 8 X 20	NR	2,000
010.7894	VITE TCEI 8 X 25	NR	4,000
010.7923	VITE TCEI 10 X 25	NR	4,000
010.7937	VITE TCEI 12 X 70	NR	4,000
010.7984	VITE TE M12X80	NR	1,000
010.7993	VITE TSPEI 5 X 12	NR	2,000
016.1223	PIASTR.FIX INTERR.SICUR.ARCHETTO	NR	2,000
016.1717	PROTEZ.CAVI SEZ.PULEGGIA MOTRICE	NR	1,000
019.5391	FASCETTA MINUS GT	NR	1,000
022.0037	INTERRUTTORE DI SICUREZZA FR 690	NR	1,000
022.0209	RACCORDO RAPIDO SEM 29 ART.3800296	NR	1,000
022.0211	RACCORDO RAPIDO SEM PG 13,5	NR	5,000
022.0212	RACCORDO RAPIDO SEM PG 16	NR	1,000
022.0244	CONTRODADO 3217B GRIGIO PG 13	NR	4,000
022.0247	DADO POLIAM.HUMMEL 1.262.2900.11	NR	1,000
022.0249	DADO POLIAM.HUMMEL 1.262.1600.11	NR	1,000
025.0555	SPAZZOLA PULILAMA 3103 0 100	NR	1,000
028.0121	RACCORDO 3/8-17 CL 2601	NR	1,000
028.0130	RACCORDO 1/4-9 CL 2601	NR	2,000
034.0432	PIASTRA DI FONDO X SCAT.APP.ELETT.	NR	1,000
034.0721	SCATOLA DI DERIVAZIONE	NR	1,000
034.1107	VOLANTINO DIAM.30 M6 X 20	NR	1,000
043.0260	TAPPO TTE4 1/4 - CL 2611	NR	1,000

Optional: gemotoriseerde zaagbandborstel

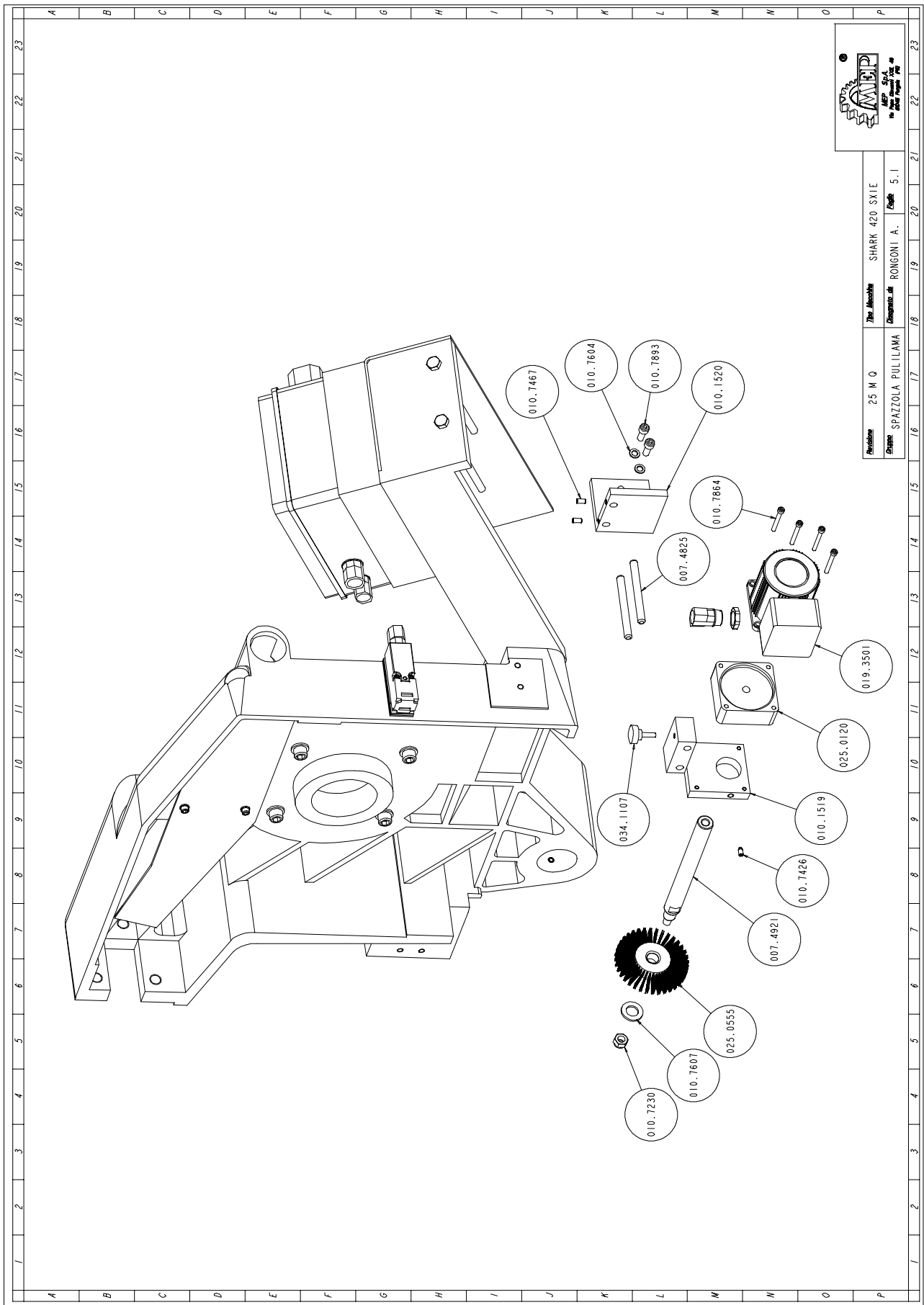

Particelle	25 M Q	The Machine	SHARK 420 SXIE
Clienti	SPAZZOLA PULLAMA	Distributore di	RONGONI A. - Emila 5. I

Art. NR.	Benaming	M.	Hoeveelheid
007.4825	PERNO DI SCORRIMENTO PER MOTORE	NR	2,000
007.4921	ALBERO PORTASPAZZOLA PULILAMA	NR	1,000
010.1519	STAFFA FISS.MOTORE SPAZZOLA PULIL.	NR	1,000
010.1520	STAFFA REGOL.SPAZZOLA MOTORIZZATA	NR	1,000
010.7230	DADO AUTOBLOCCANTE M10	NR	1,000
010.7426	GRANO VCE P.CIL. 6 X 8	NR	1,000
010.7467	GRANO VCE PUNTA PIANA 6 X 12	NR	2,000
010.7604	RONDELLA DIAM. 8	NR	2,000
010.7607	RONDELLA DIAM. 16	NR	1,000
010.7864	VITE TCEI 5 X 45	NR	4,000
010.7893	VITE TCEI 8 X 20	NR	2,000
019.3501	MOTORE PANASONIC 380-415 M8MAGK4CEX	NR	1,000
025.0120	RIDUTTORE 1/5 M8GA5B X MOT.SPAZZ.P.	NR	1,000
025.0555	SPAZZOLA PULILAMA 3103 0 100	NR	1,000
034.1107	VOLANTINO DIAM.30 M6 X 20	NR	1,000

Achterste-zaagbandgeleideblokje groep

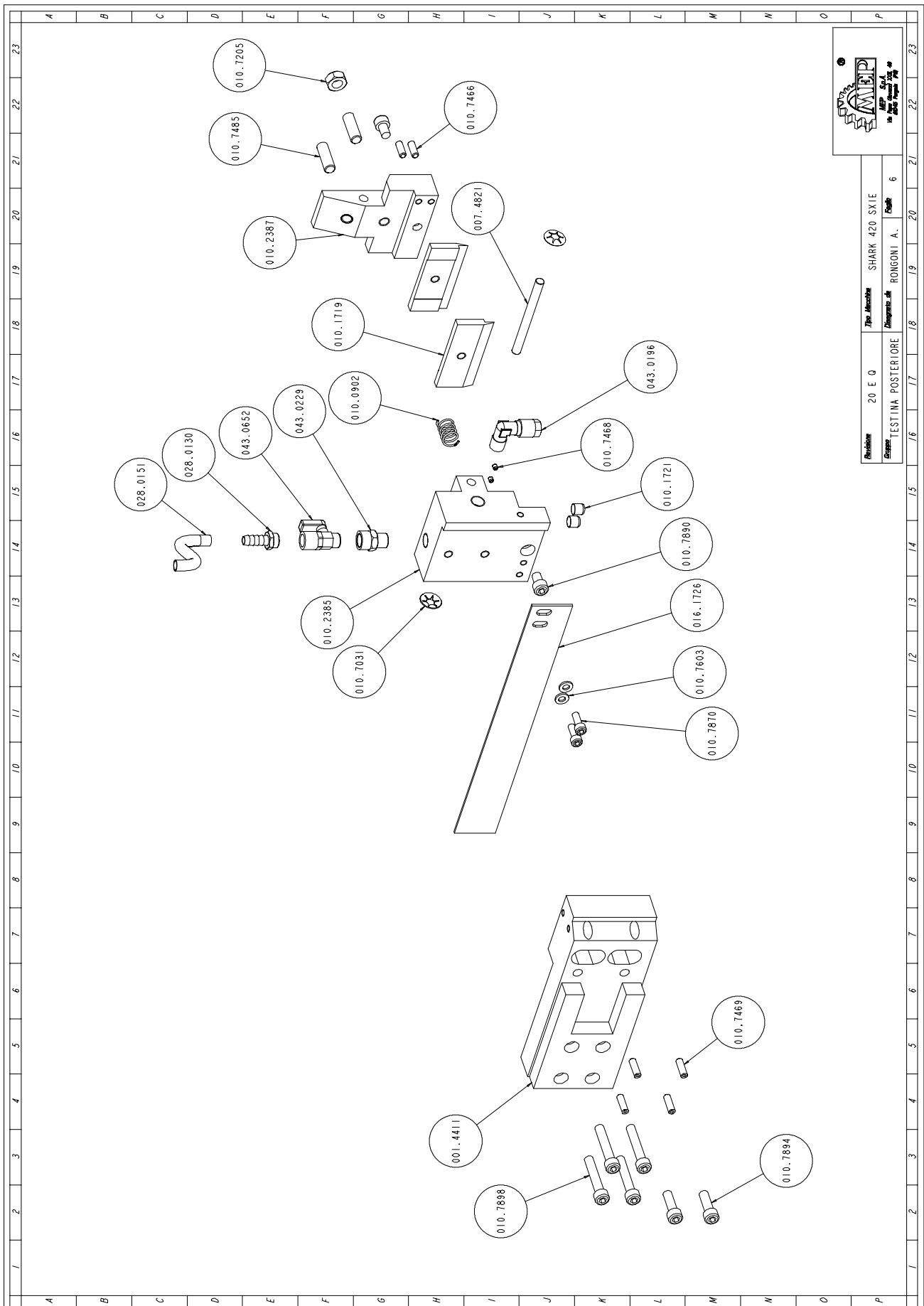

Art. NR.	Benaming	M.	Hoeveelheid
001.4411	SUPPORTO TESTINA POSTERIORE	NR	1,000
007.4821	PERNO SNODO TESTINA	NR	1,000
010.0902	MOLLE PUNTO FISSO TESTA	NR	1,000
010.1719	GUIDALAMA	NR	2,000
010.1721	PREMILAMA	NR	2,000
010.2385	TESTINA GUIDALAMA POSTERIORE FISSA	NR	1,000
010.2387	TESTINA GUIDALAMA POSTERIORE MOBILE	NR	1,000
010.7031	ANELLO SEEGER SK DIAM. 8	NR	2,000
010.7205	DADO M10	NR	1,000
010.7466	GRANO VCE PUNTA PIANA 6 X 16	NR	2,000
010.7468	GRANO VCE PUNTA PIANA 4 X 4	NR	2,000
010.7469	GRANO VCE PUNTA PIANA 6 X 20	NR	4,000
010.7485	GRANO VCE PUNTA PIANA 10X30	NR	2,000
010.7603	RONDELLA DIAM. 6	NR	2,000
010.7870	VITE TCEI 6 X 16	NR	2,000
010.7890	VITE TCEI 8 X 12	NR	2,000
010.7894	VITE TCEI 8 X 25	NR	2,000
010.7898	VITE TCEI 8 X 45	NR	4,000
016.1726	PROTEZIONE LAMA POSTERIORE TESTINA	NR	1,000
028.0130	RACCORDO 1/4-9 CL 2601	NR	1,000
028.0151	TUBO PLASTIFICATO 07-11	MT	1,000
043.0196	RACCORDO A GOMITO MF 8X1/4 CL 1020	NR	1,000
043.0229	RIDUZIONE MF 1/4 - CL 2520	NR	1,000
043.0652	RUBINETTO 1/4 F.M.	NR	1,000

Optional: besturing van zaagbandafwijking

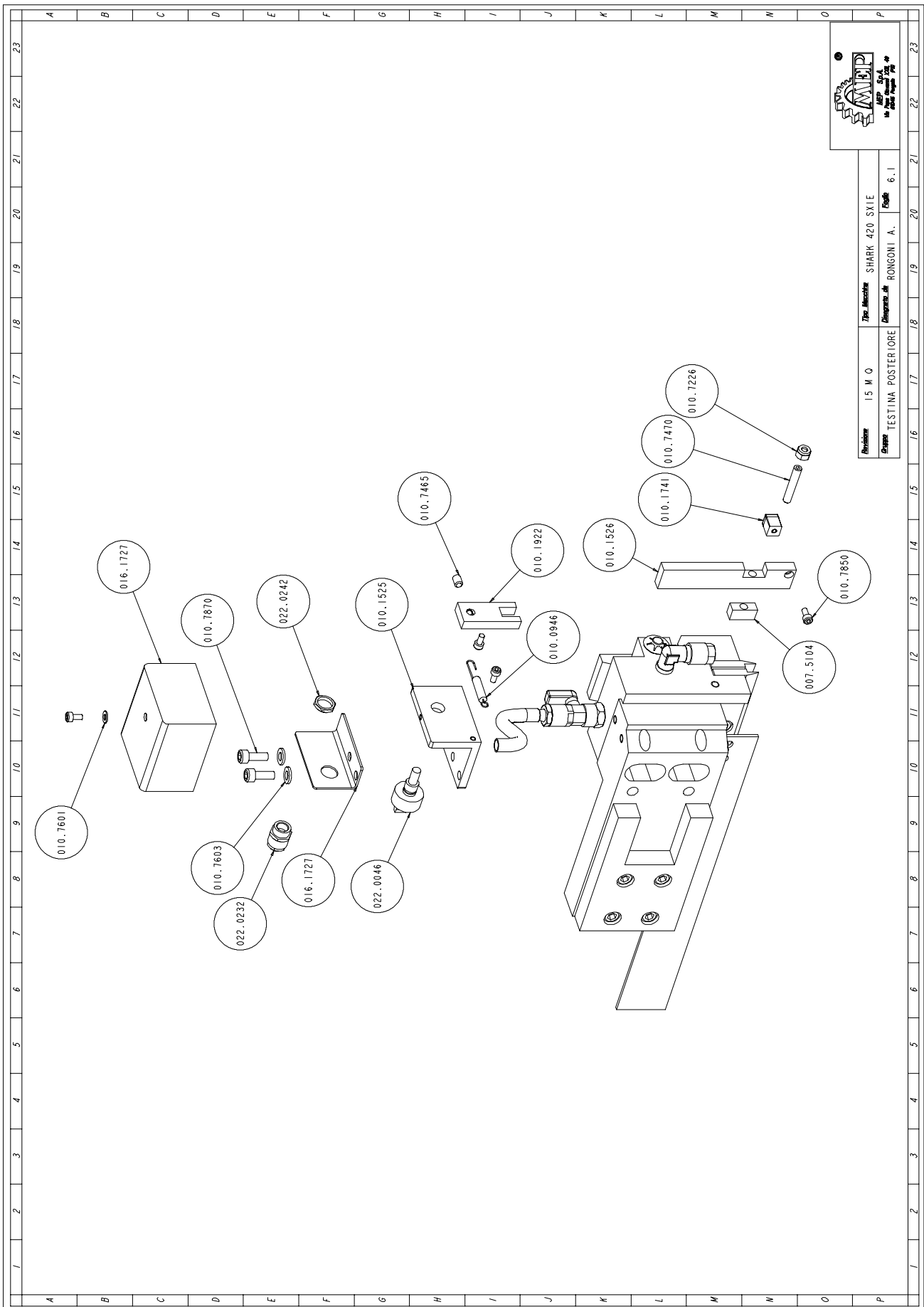

		Divisione	15 M Q	Tip. Macchine	SHARK 420 SXI E
		Gruppo	TESTINA POSTERIORE	Disegnato da	RONGONI A. - Foglio 6.1

Art. NR.	Benaming	M.	Hoeveelheid
007.5104	DISTANZIALE STAFFA TASTATORE AL	NR	1,000
010.0946	MOLLA X PULILAMA	NR	1,000
010.1525	STAFFA FIX POTENZ.CONTROLLO LAMA	NR	1,000
010.1526	STAFFA FISSAGGIO PREMILAMA	NR	1,000
010.1741	TASTATORE AL WIDIA SH 400	NR	1,000
010.1922	LEVA COMANDO PREMILAMA	NR	1,000
010.7226	DADO AUTOBLOCCANTE M6	NR	1,000
010.7465	GRANO VCE PUNTA PIANA 6 X 8	NR	1,000
010.7470	GRANO VCE PUNTA PIANA 6 X 35	NR	1,000
010.7601	RONDELLA DIAM. 4	NR	1,000
010.7603	RONDELLA DIAM. 6	NR	4,000
010.7850	VITE TCEI 4 X 8	NR	4,000
016.1726	PROTEZIONE LAMA POSTERIORE TESTINA	NR	1,000
016.1727	PROTEZIONE POTENZIOMETRO SH 400	NR	2,000
022.0046	POTENZIOMETRO 6639S-001-202	NR	1,000
022.0232	PRESSACAVO IN OTTONE 1/4 BM 2450	NR	1,000
022.0242	DADO IN OTTONE BM 2460 1/4	NR	1,000

Motor groep

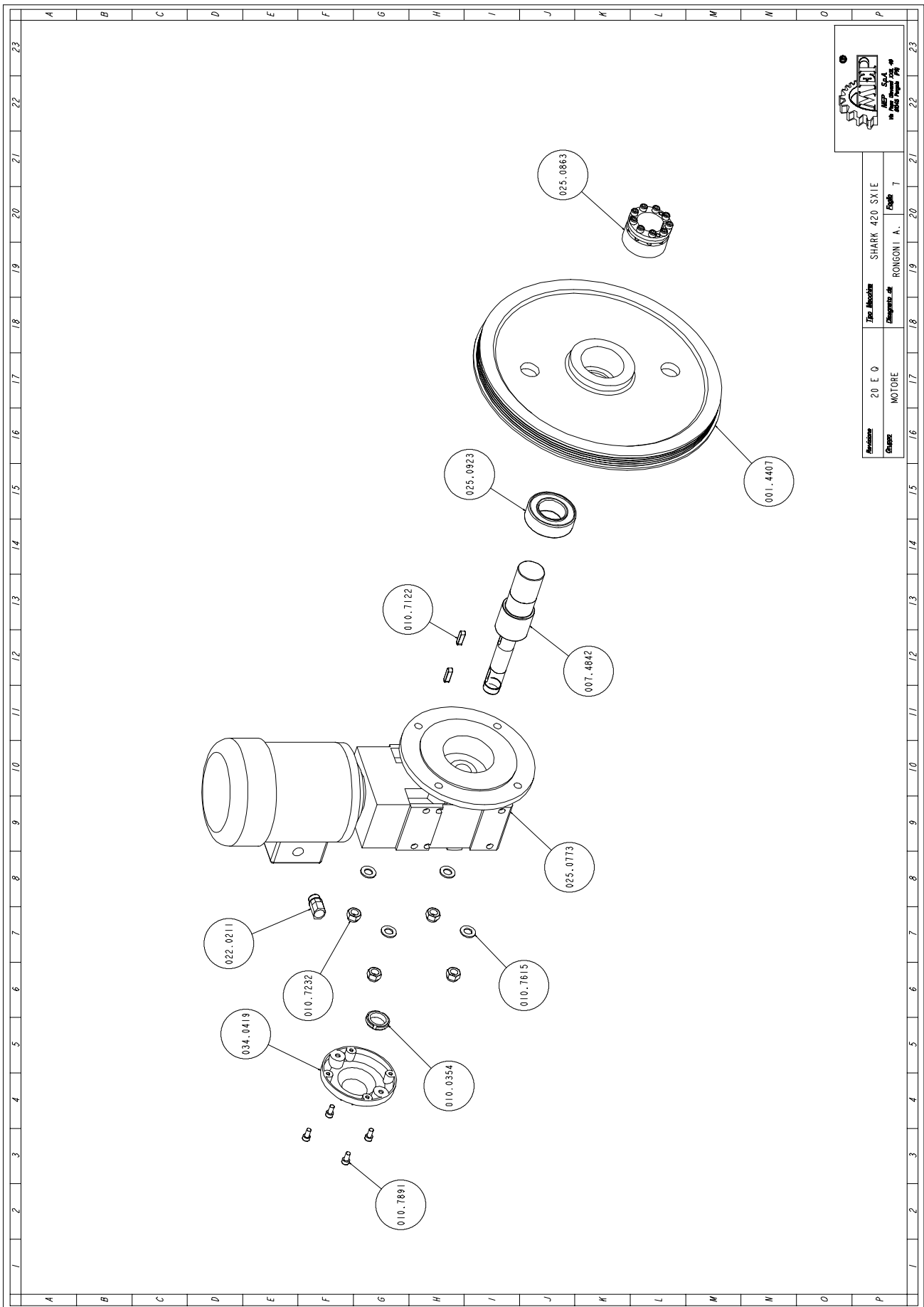

Model	SHARK 420 SXIE
Descrizione	Motore di RINGONI A. Fase 7

Art. NR.	Benaming	M.	Hoeveelheid
001.4407	PULEGGIA MOTRICE	NR	1,000
007.4842	ALBERO RIDUTTORE	NR	1,000
010.0354	GHIERA AUTOBLOCCANTE 30X1,5	NR	1,000
010.7122	CHIAVETTA 8 X 8 X 32	NR	2,000
010.7232	DADO AUTOBLOCCANTE M14	NR	4,000
010.7615	RONDELLA DIAM. 15	NR	4,000
010.7891	VITE TCEI 8 X 16	NR	4,000
022.0211	RACCORDO RAPIDO SEM PG 13,5	NR	1,000
025.0773	MOTORIDUTTORE A 20 2 F1C 53,7 S3	NR	1,000
025.0863	CALETTATORE TLK 130 50X80	NR	1,000
025.0923	CUSCINETTO 3210E-2RS	NR	1,000
034.0419	COPERCHIO RIDUTTORE SH 320	NR	1,000

Dwarsbalk groep

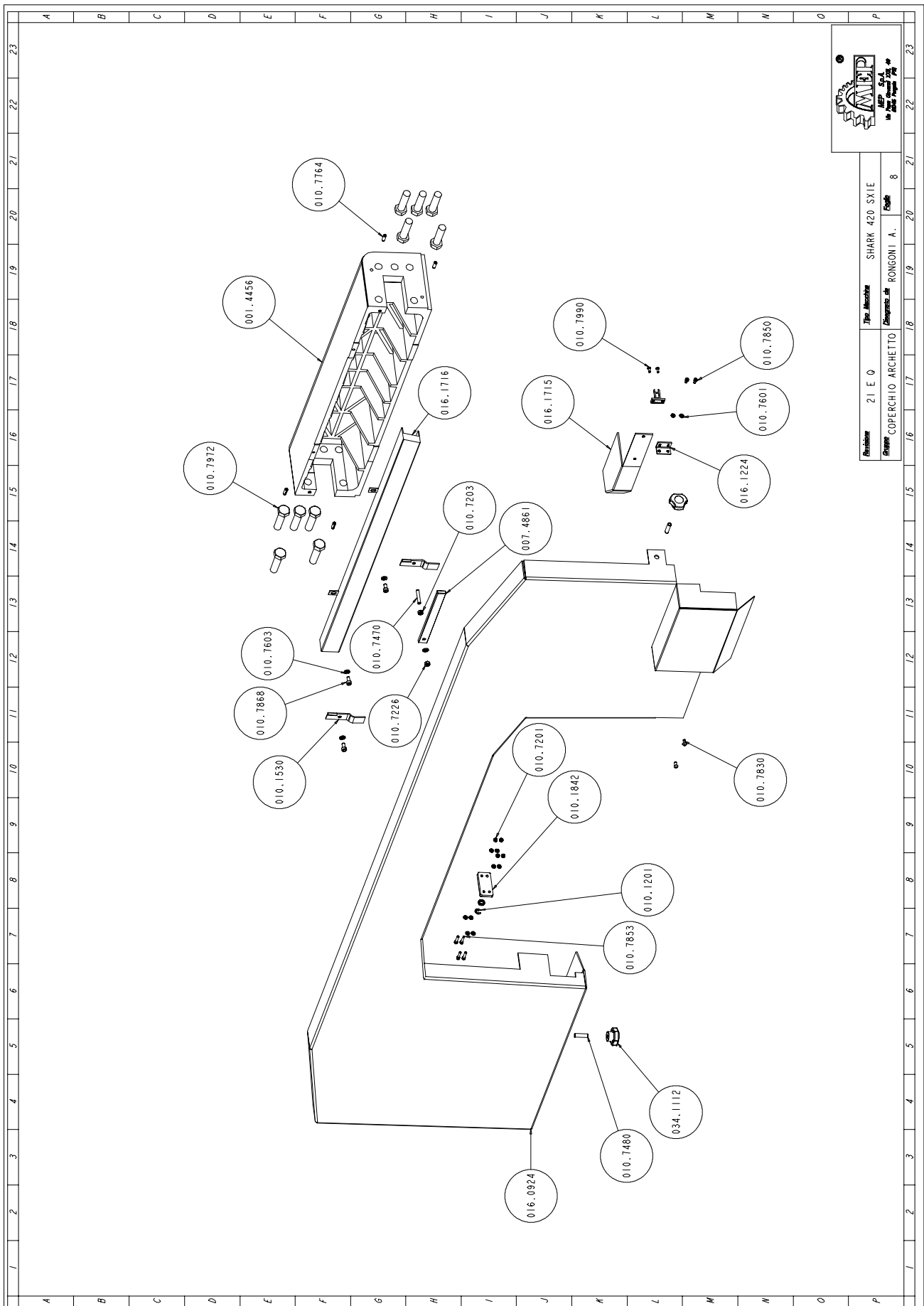

Revisione	21 E 0	Tip. Macchine	SHARK 420 SXIE
Disegnato da	COPERCHIO ARCHETTO	Elaborato da	RONGONI A.
		Foglio	8

Art. NR.	Benaming	M.	Hoeveelheid
001.4456	TRAVE DELL'ARCHETTO	NR	1,000
007.4861	SOSTEGNO COPERCHIO ARCHETTO	NR	1,000
010.1201	VITERIA E BULLONERIA	NR	1,000
010.1530	STAFFA DI FERMO SH 400	NR	2,000
010.1842	SUPPORTO MASCHIO X MOLLA A GAS	NR	1,000
010.7201	DADO M4	NR	4,000
010.7203	DADO M6	NR	1,000
010.7226	DADO AUTOBLOCCANTE M6	NR	1,000
010.7470	GRANO VCE PUNTA PIANA 6 X 35	NR	1,000
010.7480	GRANO VCE PUNTA PIANA 8 X 30	NR	2,000
010.7601	RONDELLA DIAM. 4	NR	10,000
010.7603	RONDELLA DIAM. 6	NR	4,000
010.7764	SPINA ELASTICA DIAM. 6 X 20	NR	4,000
010.7830	VITE BUTON 5 X 10	NR	2,000
010.7850	VITE TCEI 4 X 8	NR	2,000
010.7853	VITE TCEI 4 X 20	NR	4,000
010.7868	VITE TCEI 6 X 12	NR	3,000
010.7972	VITE TE 16X60	NR	10,000
010.7990	VITE TSPEI 4 X 8	NR	2,000
016.0924	COPERCHIO ARCHETTO SH 420 SE	NR	1,000
016.1224	PIASTR.FIX INTER.SICUR.COPERCHIO	NR	1,000
016.1715	PROTEZIONE LAMA POST.CARTER LAMA	NR	1,000
016.1716	PROTEZIONE CAVI TRAVE	NR	1,000
034.1112	VOLANTINO DIAM.40 M8	NR	2,000

Doorsnede-loopwiel groep

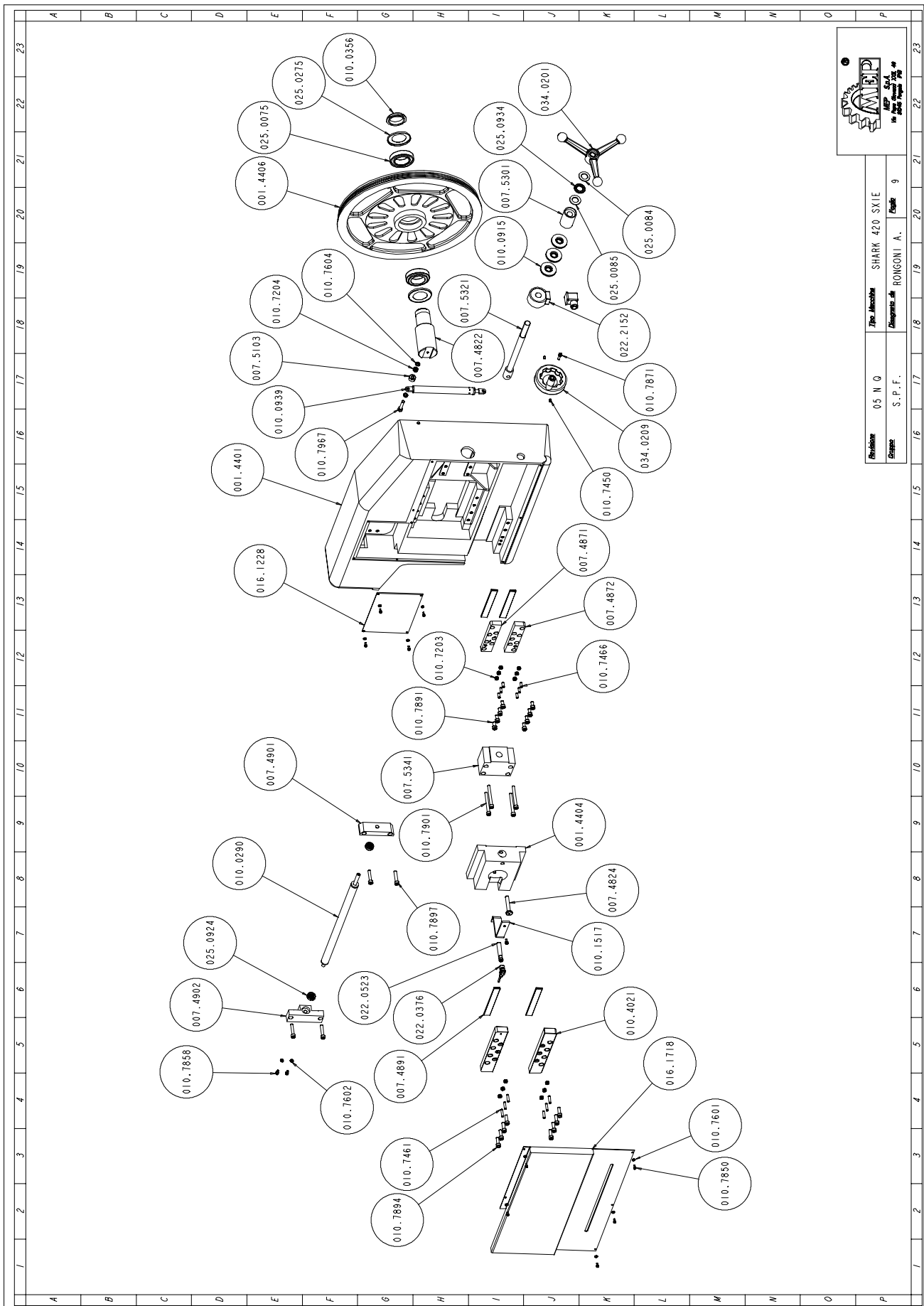

Art. NR.	Benaming	M.	Hoeveelheid
001.4401	ARCHETTO SEZIONE PULEGGIA FOLLE	NR	1,000
001.4404	SLITTA TENDILAMA	NR	1,000
001.4406	PULEGGIA FOLLE	NR	1,000
007.4822	PERNO PULEGGIA FOLLE	NR	1,000
007.4824	PERNO BLOCCAGGIO SLITTA TENDILAMA	NR	1,000
007.4871	PIASTRA SUP.REG.LARDONE SUPP.TEST.	NR	1,000
007.4872	PIASTRA INF.REG.LARDONE SUPP.TEST.	NR	1,000
007.4891	LARDONE SLITTA TEND.E SUPP.TEST.ANT	NR	4,000
007.4901	SUPP.POST.X VITE TRASC.TEST.ANT.	NR	1,000
007.4902	SUPP.ANT.X VITE TRASC.TEST.ANTER.	NR	1,000
007.5103	DISTANZIALE MOLLA A GAS SH 400	NR	1,000
007.5301	DISTANZIALE TENSIONAMENTO LAMA	NR	1,000
007.5321	PERNO X TENSIONAMENTO LAMA SH 420SE	NR	1,000
007.5341	SUPPORTO TENSIONAMENTO LAMA SH420SE	NR	1,000
010.0290	VITE SUPPORTO TESTINA GUIDALAMA	NR	1,000
010.0356	GHIERA AUTOBLOCCANTE 45X1,5	NR	1,000
010.0915	MOLLA A TAZZA	NR	6,000
010.0939	MOLLA A GAS 300 MM.300N	NR	1,000
010.4021	PIASTRA REGOLAZIONE SLITTA LARDONE	NR	2,000
010.7203	DADO M6	NR	12,000
010.7204	DADO M8	NR	1,000
010.7450	GRANO VCE P.CIL. 6 X 6	NR	2,000
010.7461	GRANO VCE PUNTA PIANA 6 X 25	NR	6,000
010.7466	GRANO VCE PUNTA PIANA 6 X 16	NR	6,000
010.7601	RONDELLA DIAM. 4	NR	9,000
010.7602	RONDELLA DIAM. 5	NR	2,000
010.7604	RONDELLA DIAM. 8	NR	2,000
010.7850	VITE TCEI 4 X 8	NR	9,000
010.7858	VITE TCEI 5 X 10	NR	2,000
010.7871	VITE TCEI 6 X 20	NR	1,000
010.7891	VITE TCEI 8 X 16	NR	8,000
010.7894	VITE TCEI 8 X 25	NR	8,000
010.7897	VITE TCEI 8 X 40	NR	4,000
010.7901	VITE TCEI 8 X 75	NR	4,000
010.7967	VITE TE 8 X 40	NR	1,000
016.1228	PIASTRA CHIUSURA ARCHETTO ANTERIORE	NR	1,000
016.1718	PROTEZIONE SLITTA TENDILAMA	NR	1,000
022.0369	CONNETTORE PER BOBINA U2	NR	1,000
022.2152	TENSIONATORE ELETTRONICO 02	NR	1,000
025.0075	CUSCINETTO 32009X	NR	2,000
025.0084	RALLA GS 81104	NR	1,000
025.0085	RALLA WS 81104	NR	1,000
025.0275	ANELLO DI PROTEZIONE NILOS 32009X	NR	2,000
025.0924	CUSCINETTO 6000 Z	NR	2,000
025.0934	GABBIA ASSIALE K81104	NR	1,000
034.0201	VOLANTINO MORSA GRANDE	NR	1,000
034.0209	VOLANTINO VDO.100 ALIMENTATORE	NR	1,000

Optional: gemotoriseerde zaagbandgeleider - hydraulisch spannen

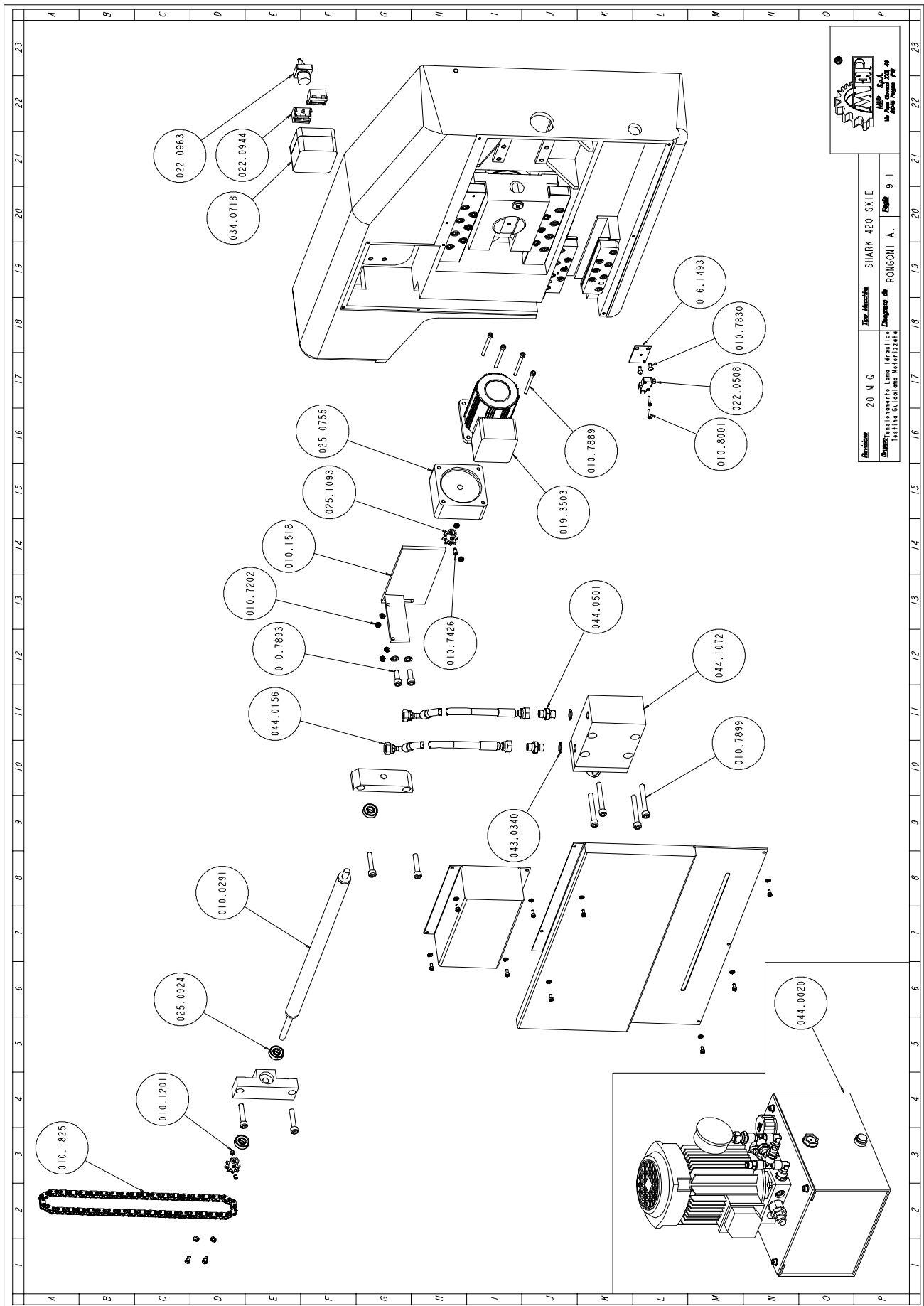

Art. NR.	Benaming	M.	Hoeveelheid
010.0291	VITE SUPP.TESTINA GUIDALAMA ANTER.	NR	1,000
010.1201	VITERIA E BULLONERIA	NR	2,000
010.1518	STAFFA FISS.MOTORE AVANZ.TESTINA	NR	1,000
010.1825	CATENA SEMPL. 3/8 SH 400	NR	1,000
010.7202	DADO M5	NR	4,000
010.7426	GRANO VCE P.CIL. 6 X 8	NR	1,000
010.7830	VITE BUTON 5 X 10	NR	2,000
010.7889	VITE TCEI 5 X 60	NR	4,000
010.7893	VITE TCEI 8 X 20	NR	6,000
010.7899	VITE TCEI 8 X 60	NR	4,000
010.8001	VITE TCIC M3X16	NR	2,000
016.1493	STAFFA FISS.F.C.SUPP.TEST.ANTERIORE	NR	1,000
019.3503	MOTORE M9MA40GK4CE1 V.380-415 AVAN-	NR	1,000
022.0508	FINECORSA V5B010 CB1	NR	1,000
022.0944	BLOCCHETTO V.50 NORMALMENTE APERTO	NR	2,000
022.0963	SELETTORE INST. QM383-VOCN NOT/AUS	NR	1,000
025.0755	RIDUTTORE 1/5 M9GABB AVANZAMENTO	NR	1,000
025.0924	CUSCINETTO 6000 Z	NR	3,000
034.0718	SCATOLA X EMERGENZA	NR	1,000
043.0340	RONDELLA RAME 13X19X1,5-1/4	NR	2,000
044.0156	TUBO CENTRALINA MM 4000 1X90Ø	NR	2,000
044.0501	NIPPLO NP 1/4 IDRAULICO	NR	2,000
044.0020	MONOCENTRALINA IDRAULICA COMPLETA	NR	1,000
044.1072	CILINDRO IDRAULICO DDW552260 PK C60	NR	1,000

Voorste-geleideblokje groep

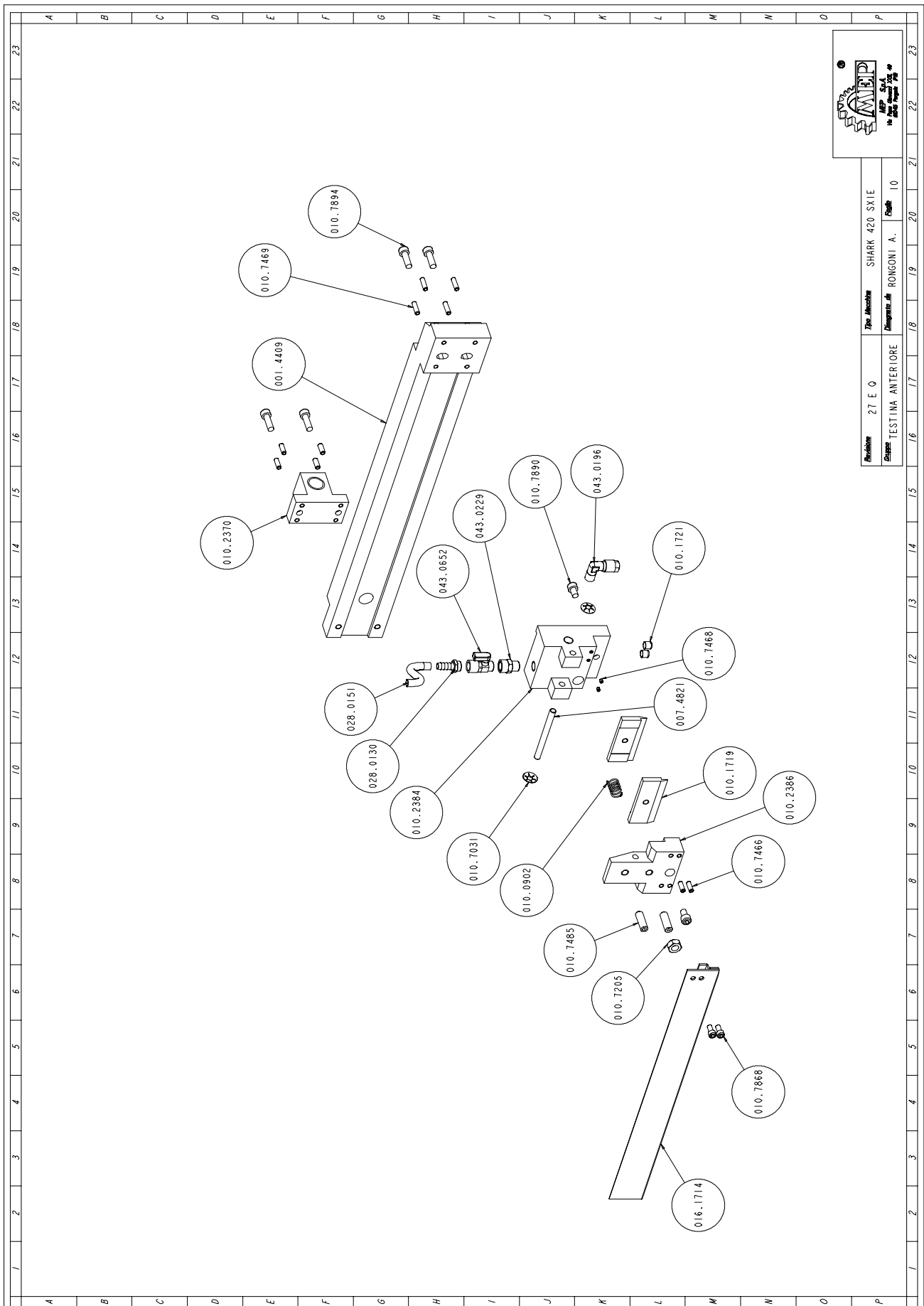

Revisione	27 E 0	Tipo Macchina	SHARK 420 SXI E
Gruppo	TESTINA ANTERIORE	Disegnato da	RONGONI A.
		Scala	1:0

Art. NR.	Benaming	M.	Hoeveelheid
001.4409	STAFFA SUPPORTO TESTINA ANTERIORE	NR	1,000
007.4821	PERNO SNODO TESTINA	NR	1,000
010.0902	MOLLE PUNTO FISSO TESTA	NR	1,000
010.1719	GUIDALAMA	NR	2,000
010.1721	PREMILAMA	NR	2,000
010.2370	CHIOCCIOLA SUPP.TEST.GUID.ANTERIORE	NR	1,000
010.2384	TESTINA GUIDALAMA ANTERIORE FISSA	NR	1,000
010.2386	TESTINA GUIDALAMA ANTERIORE MOBILE	NR	1,000
010.7031	ANELLO SEEGER SK DIAM. 8	NR	2,000
010.7205	DADO M10	NR	1,000
010.7466	GRANO VCE PUNTA PIANA 6 X 16	NR	6,000
010.7468	GRANO VCE PUNTA PIANA 4 X 4	NR	2,000
010.7469	GRANO VCE PUNTA PIANA 6 X 20	NR	4,000
010.7485	GRANO VCE PUNTA PIANA 10X30	NR	2,000
010.7868	VITE TCEI 6 X 12	NR	2,000
010.7890	VITE TCEI 8 X 12	NR	2,000
010.7894	VITE TCEI 8 X 25	NR	4,000
016.1714	PROTEZIONE LAMA ANTERIORE	NR	1,000
028.0130	RACCORDO 1/4-9 CL 2601	NR	1,000
028.0151	TUBO PLASTIFICATO 07-11	MT	1,000
043.0196	RACCORDO A GOMITO MF 8X1/4 CL 1020	NR	1,000
043.0229	RIDUZIONE MF 1/4 - CL 2520	NR	1,000
043.0652	RUBINETTO 1/4 F.M.	NR	1,000

Cilindergroep

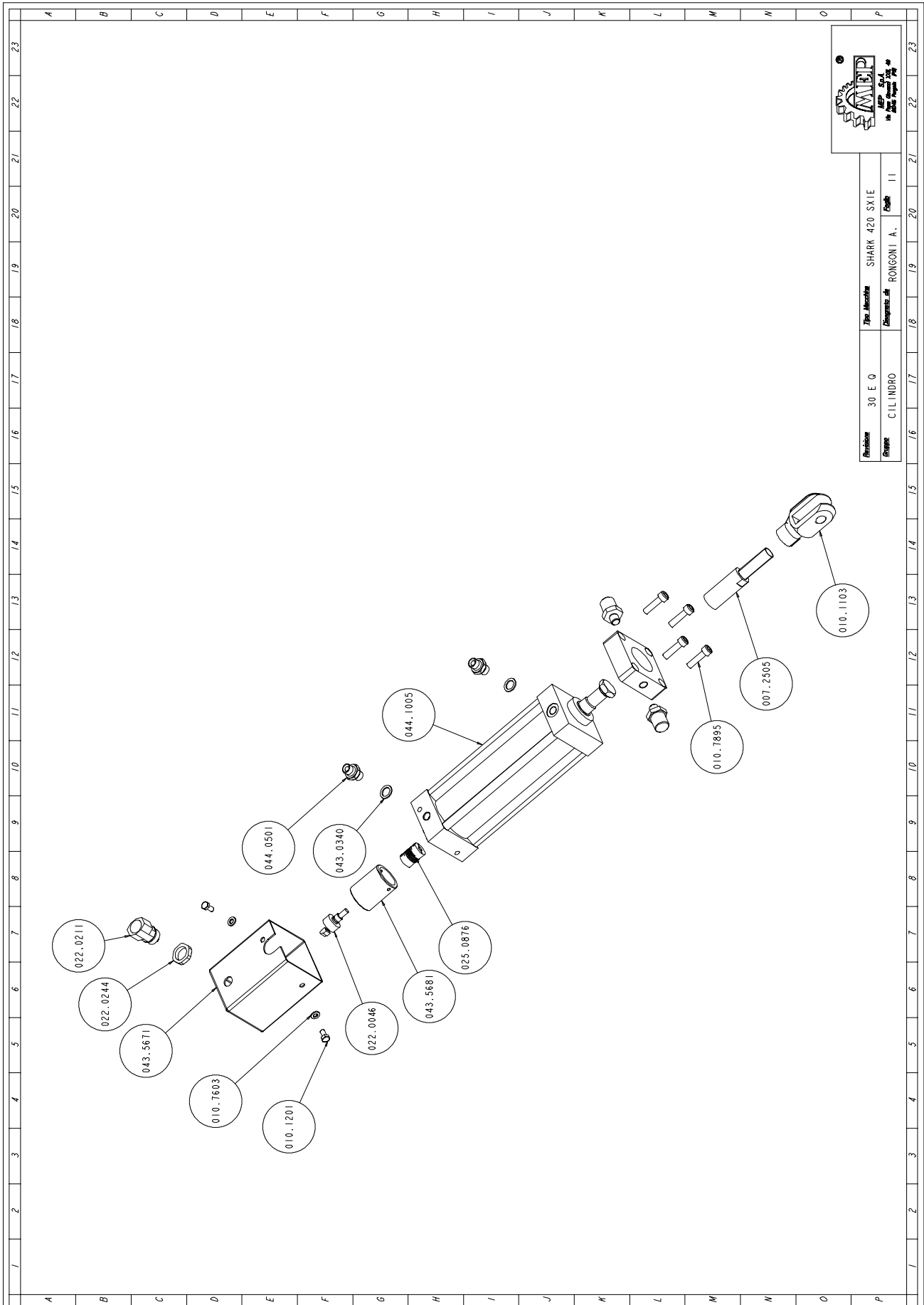

Art. NR.	Benaming	M.	Hoeveelheid
007.2505	PROLUNGA FORCELLA	NR	1,000
007.5373	PROLUNGA TESTATA ANTERIORE CILINDRO	NR	1,000
010.1103	FORCELLA 16 X 1,5	NR	1,000
010.1201	VITERIA E BULLONERIA	NR	2,000
010.7603	RONDELLA DIAM. 6	NR	2,000
010.7895	VITE TCEI 8 X 30	NR	4,000
022.0046	POTENZIOMETRO 6639S-001-202	NR	1,000
022.0211	RACCORDO RAPIDO SEM PG 13,5	NR	1,000
022.0244	CONTRODADO 3217B GRIGIO PG 13	NR	1,000
025.0876	GIUNTO WA 6-6 MM.28 X CILINDRO	NR	1,000
043.0340	RONDELLA RAME 13X19X1,5-1/4	NR	2,000
043.5671	PROTEZIONE POTENZIOMETRO CILINDRO	NR	1,000
043.5681	SUPPORTO POTENZIOMETRO CILINDRO	NR	1,000
044.0501	NIPPLO NP 1/4 IDRAULICO	NR	2,000
044.1005	CILINDRO IDRAULICO	NR	1,000

Optional: elektronische cilindergroep (besturing zaagkracht)

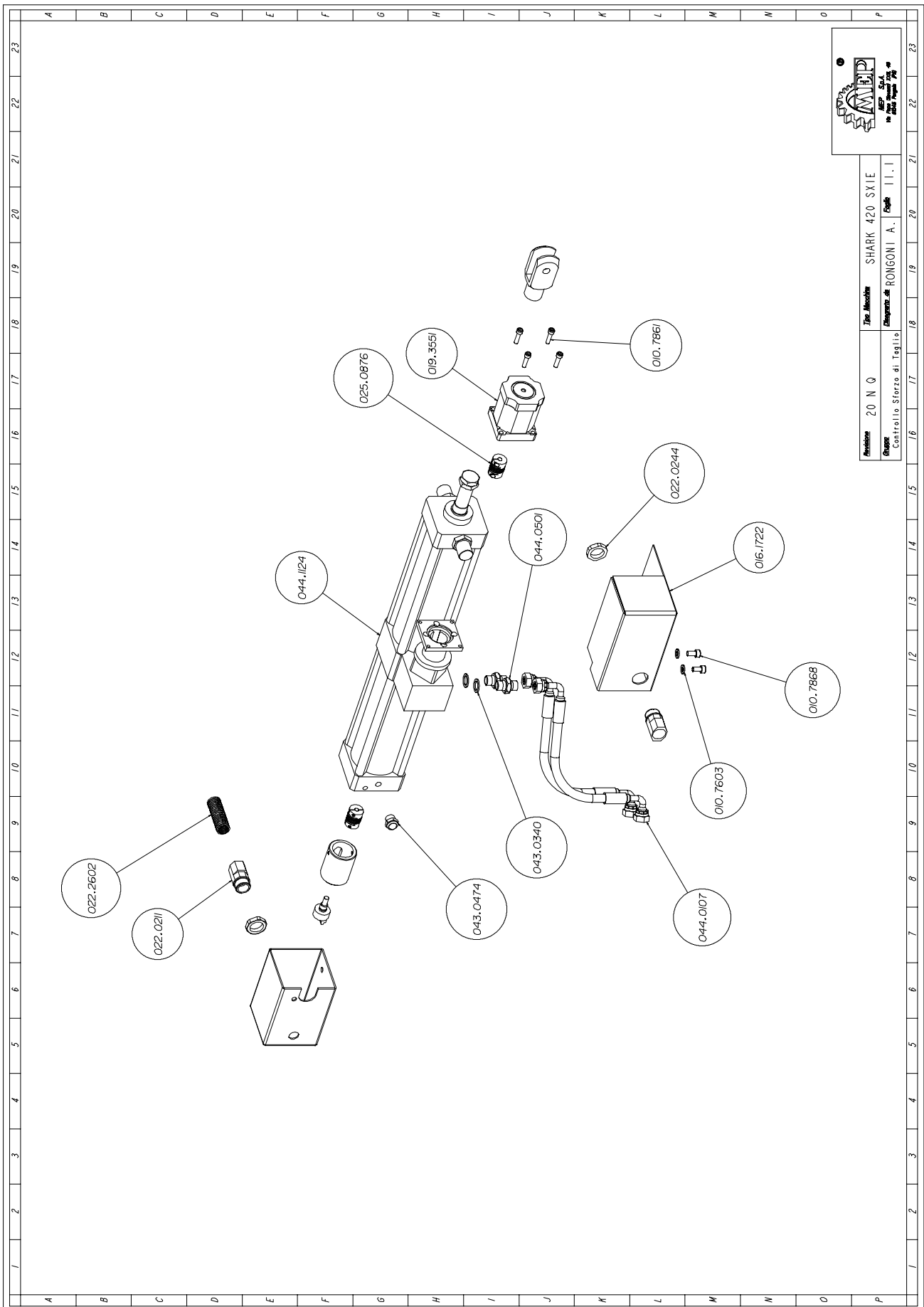

Art. NR.	Benaming	M.	Hoeveelheid
010.1103	FORCELLA 16 X 1,5	NR	1,000
010.7603	RONDELLA DIAM. 6	NR	2,000
010.7861	VITE TCEI 5 X 20	NR	4,000
010.7868	VITE TCEI 6 X 12	NR	2,000
016.1722	PROTEZIONE CILINDRO	NR	1,000
019.3551	MOTORE MAE MOD.HY 200 2232 190B8CNC	NR	1,000
022.0046	POTENZIOMETRO 6639S-001-202	NR	1,000
022.0211	RACCORDO RAPIDO SEM PG 13,5	NR	2,000
022.0244	CONTRODADO 3217B GRIGIO PG 13	NR	2,000
022.2602	GUAINA POLIFLEX NW 14-1200143	MT	1,000
025.0876	GIUNTO WA 6-6 MM.28 X CILINDRO	NR	2,000
043.0340	RONDELLA RAME 13X19X1,5-1/4	NR	2,000
043.0474	SILENZIATORE IN OTTONE 1/4"	NR	1,000
043.5671	PROTEZIONE POTENZIOMETRO CILINDRO	NR	1,000
043.5681	SUPPORTO POTENZIOMETRO CILINDRO	NR	1,000
044.0107	TUBO CENTR. R7-1/4 1500MM 2X90Ø	NR	2,000
044.0501	NIPPLO NP 1/4 IDRAULICO	NR	2,000
044.1124	CILINDRO IDRAULICO 0 63 C.150 SH400	NR	1,000

Rollenbanen

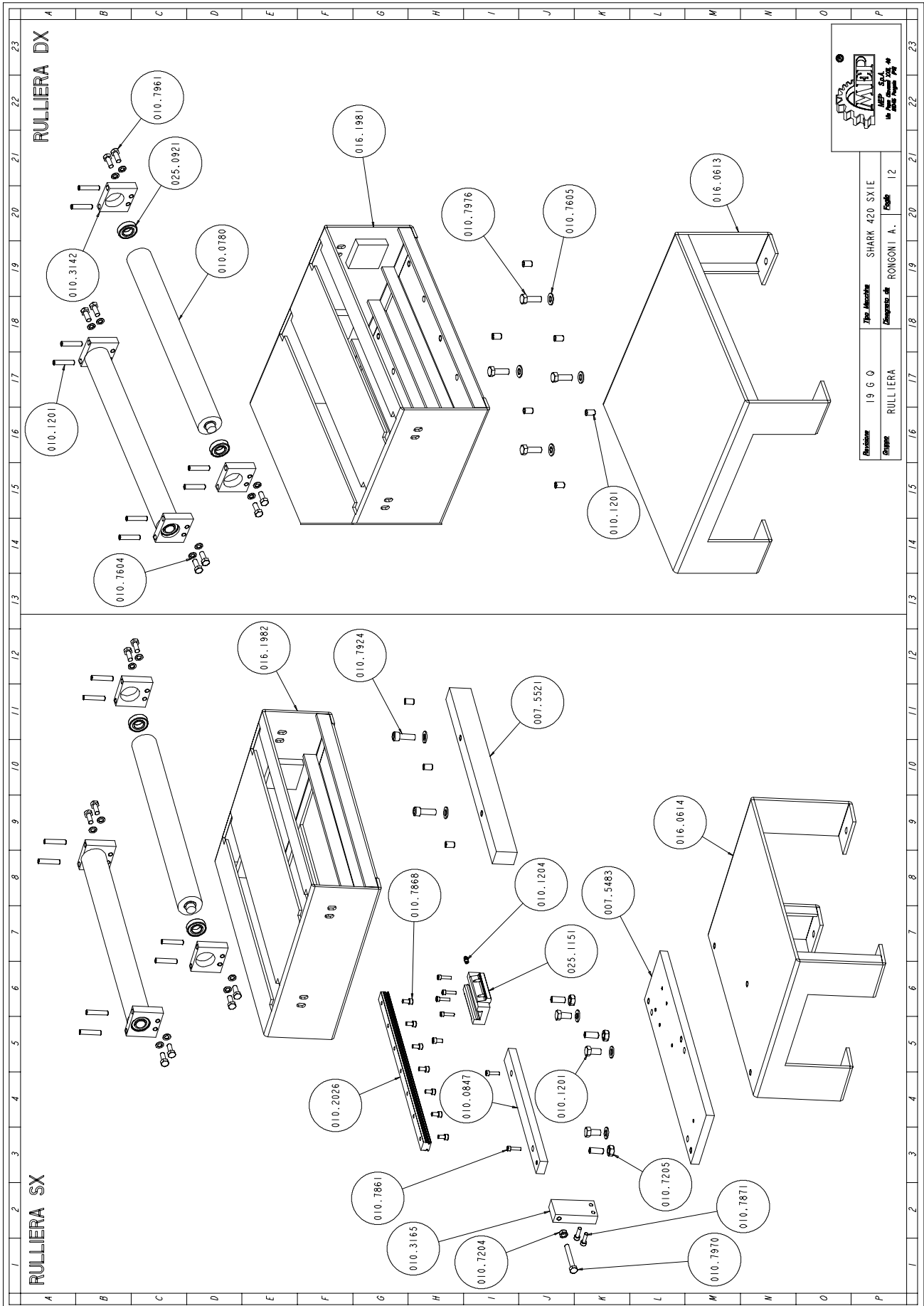

Art. NR.	Benaming	M.	Hoeveelheid
007.5483	PIASTRA FISSAGGIO RULLIERA SINISTRA	NR	1,000
007.5521	APPOGGIO REGOLABILE PER RULLIERA	NR	1,000
010.0780	RULLO 0 45 X RULLIERA SH 420 SXI	NR	1,000
010.0847	SUPPORTO GUIDA PATTINO DX-SX SH 420	NR	1,000
010.1201	VITERIA E BULLONERIA	NR	17,000
010.1204	INGRASSATORE M 6	NR	1,000
010.2026	GUIDA PATTINO LGR20 MT.0,400 PER	NR	1,000
010.3142	SUPPORTO X RULLO 0 45 RULLIERA SH	NR	2,000
010.3165	BATTUTA X RULLIERA DX-SX SH 420 SE	NR	1,000
010.7204	DADO M8	NR	1,000
010.7205	DADO M10	NR	3,000
010.7604	RONDELLA DIAM. 8	NR	8,000
010.7605	RONDELLA DIAM. 10	NR	5,000
010.7861	VITE TCEI 5 X 20	NR	6,000
010.7868	VITE TCEI 6 X 12	NR	7,000
010.7871	VITE TCEI 6 X 20	NR	2,000
010.7924	VITE TCEI 10 X 30	NR	2,000
010.7961	VITE TE 8 X 20	NR	8,000
010.7970	VITE TE 8 X 60	NR	1,000
016.0614	SUPPORTO X RULLIERA SX SH 420 SE	NR	1,000
016.1982	CORPO RULLIERA SINISTRA SH 420 SXI	NR	1,000
025.0921	CUSCINETTO 6003 2Z	NR	2,000
025.1151	PATTINO LGW20HAZ1C	NR	1,000
090.2504	RULLIERA APPOGGIA BARRA SINISTRA	NR	1,000

Art. NR.	Benaming	M.	Hoeveelheid
010.1201	VITERIA E BULLONERIA	NR	14,000
010.7604	RONDELLA DIAM. 8	NR	8,000
010.7605	RONDELLA DIAM. 10	NR	4,000
010.7961	VITE TE 8 X 20	NR	8,000
010.7976	VITE TE 10 X 30	NR	4,000
016.0613	SUPPORTO X RULLIERA DESTRA SH 420SE	NR	1,000
016.1981	CORPO RULLIERA DESTRA SH 420 SXI	NR	1,000
090.2503	RULLIERA APPOGGIA BARRA DESTRA	NR	1,000

Bedieningspaneel groep

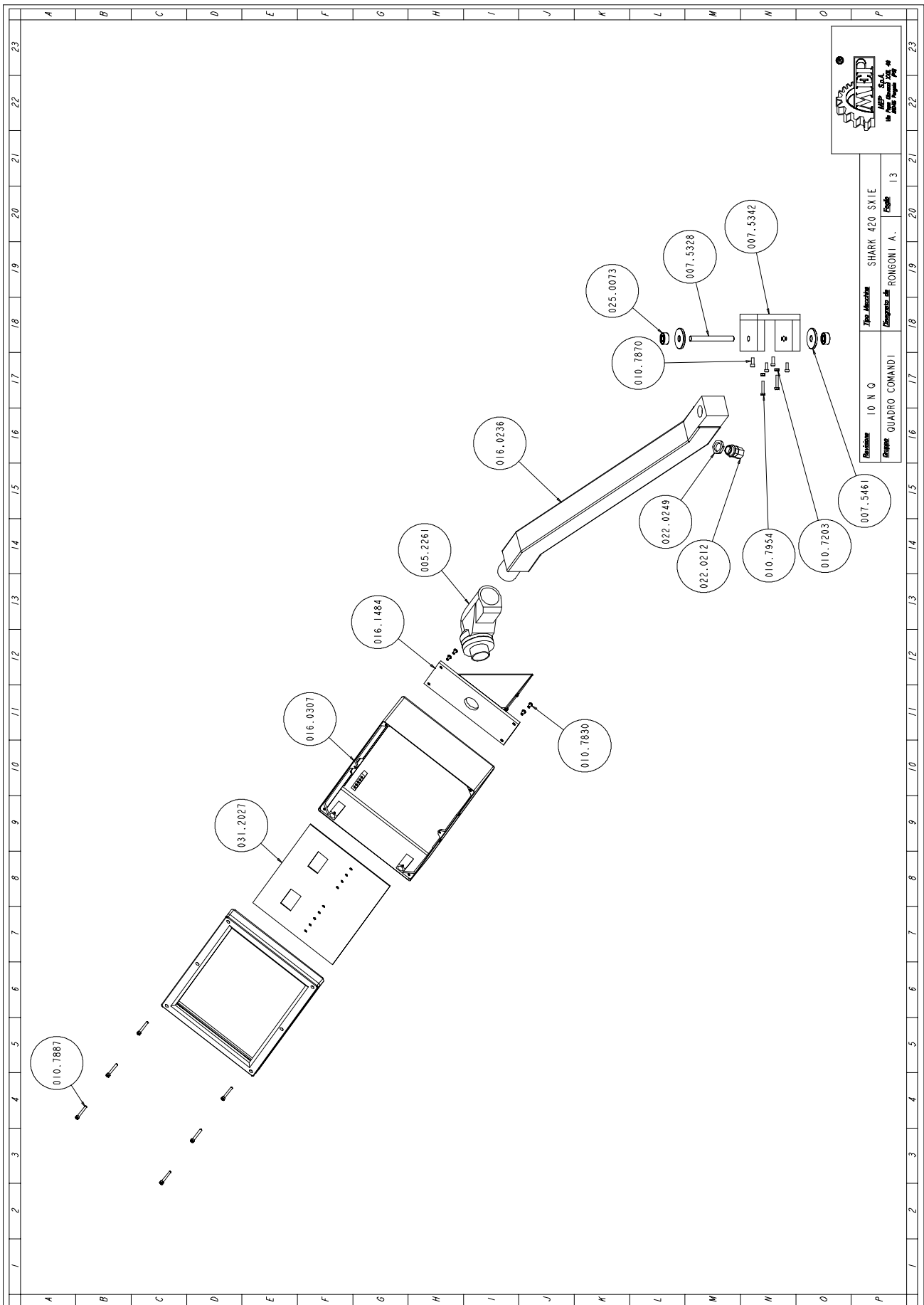

Art. NR.	Benaming	M.	Hoeveelheid
005.2261	GIUNTO ANGOLO X QUADRO 497500	NR	1,000
007.5328	PERNO PER CUSCINETTO ASTA MOBILE	NR	1,000
007.5342	SUPPORTO ASTA MOBILE SH 420 SE	NR	1,000
007.5461	ROSETTA ASTA MOBILE SH 420 SE	NR	2,000
010.7203	DADO M6	NR	2,000
010.7830	VITE BUTON 5 X 10	NR	8,000
010.7870	VITE TCEI 6 X 16	NR	4,000
010.7887	VITE TCEI 5 X 40	NR	6,000
010.7954	VITE TE 6 X 30	NR	2,000
016.0236	ASTA MOBILE X CONSOLLE SH 420 SE	NR	1,000
016.0307	QUADRO COMANDI MEP-E	NR	1,000
016.1484	STAFFA FISSAGGIO CONSOLLE SH 420 SE	NR	1,000
022.0212	RACCORDO RAPIDO SEM PG 16	NR	1,000
022.0249	DADO POLIAM.HUMMEL 1.262.1600.11	NR	1,000
025.0073	CUSCINETTO 63001 2RS	NR	2,000
031.2027	CONSOLLE DI PROGRAMMAZIONE SH 420	NR	1,000