

Explosietekeningen

In het nu volgende deel zijn de explosietekeningen van de machine opgenomen. De tekeningen met hun volledige details kunnen helpen de machine beter te leren kennen.

Motorgroep

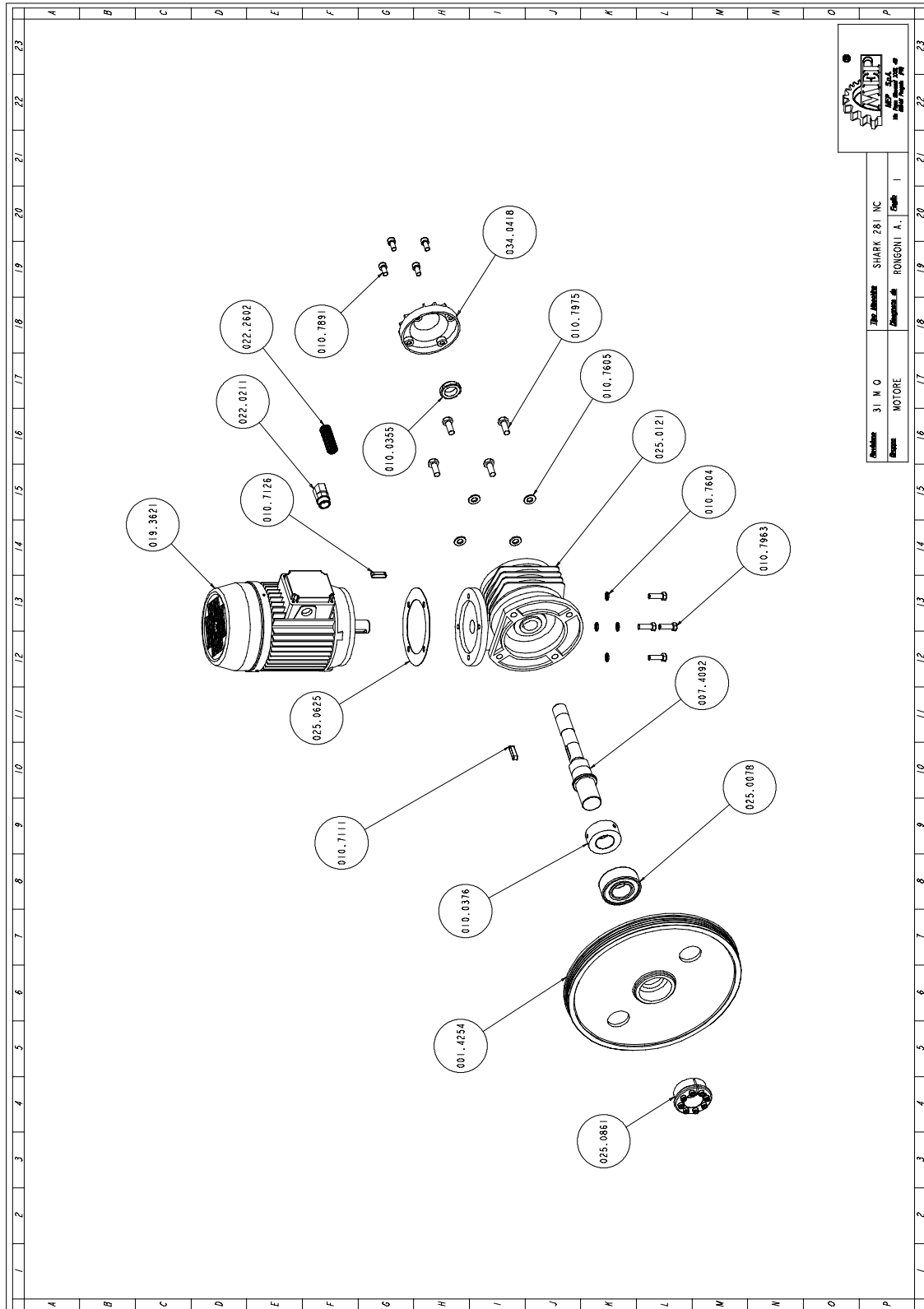

Art. NR.	Benaming	M.	Hoeveelheid
001.4254	PULEGGIA MOTRICE	NR	1,000
007.4092	ALBERO RIDUTTORE CON GHIERA SH	NR	1,000
010.0355	GHIERA AUTOBLOCCANTE 25X1,5	NR	1,000
010.0376	GHIERA X ALBERO RIDUTTORE SH 2	NR	1,000
010.7111	CHIAVETTA 8 X 7 X 32	NR	1,000
010.7126	CHIAVETTA 8 X 7 X 28	NR	1,000
010.7604	RONDELLA DIAM. 8	NR	4,000
010.7605	RONDELLA DIAM. 10	NR	4,000
010.7871	VITE TCEI 6 X 20	NR	8,000
010.7891	VITE TCEI 8 X 16	NR	4,000
010.7963	VITE TE 8 X 25	NR	4,000
010.7975	VITE TE 10 X 25	NR	4,000
019.1706	HP 2/2,5 2/4P V.380 B14 FC90L	NR	1,000
019.3621	KW 1,5 M90L4 B14 V.230-400 SH	NR	1,000
022.0211	RACCORDO RAPIDO SEM PG 13,5	NR	1,000
022.2602	GUAINA POLIFLEX NW 14-1200143	MT	1,000
025.0078	CUSCINETTO 3207A-2RS1TN9	NR	1,000
025.0121	RIDUTTORE MVF 63 FCO 1A38 90 B	NR	1,000
025.0625	GUARNIZIONE MOTORE	NR	1,000
025.0861	CALETTATORE 0 35X60	NR	1,000
034.0418	COPERCHIO RIDUTTORE	NR	1,000

Doorsnede loopwiel

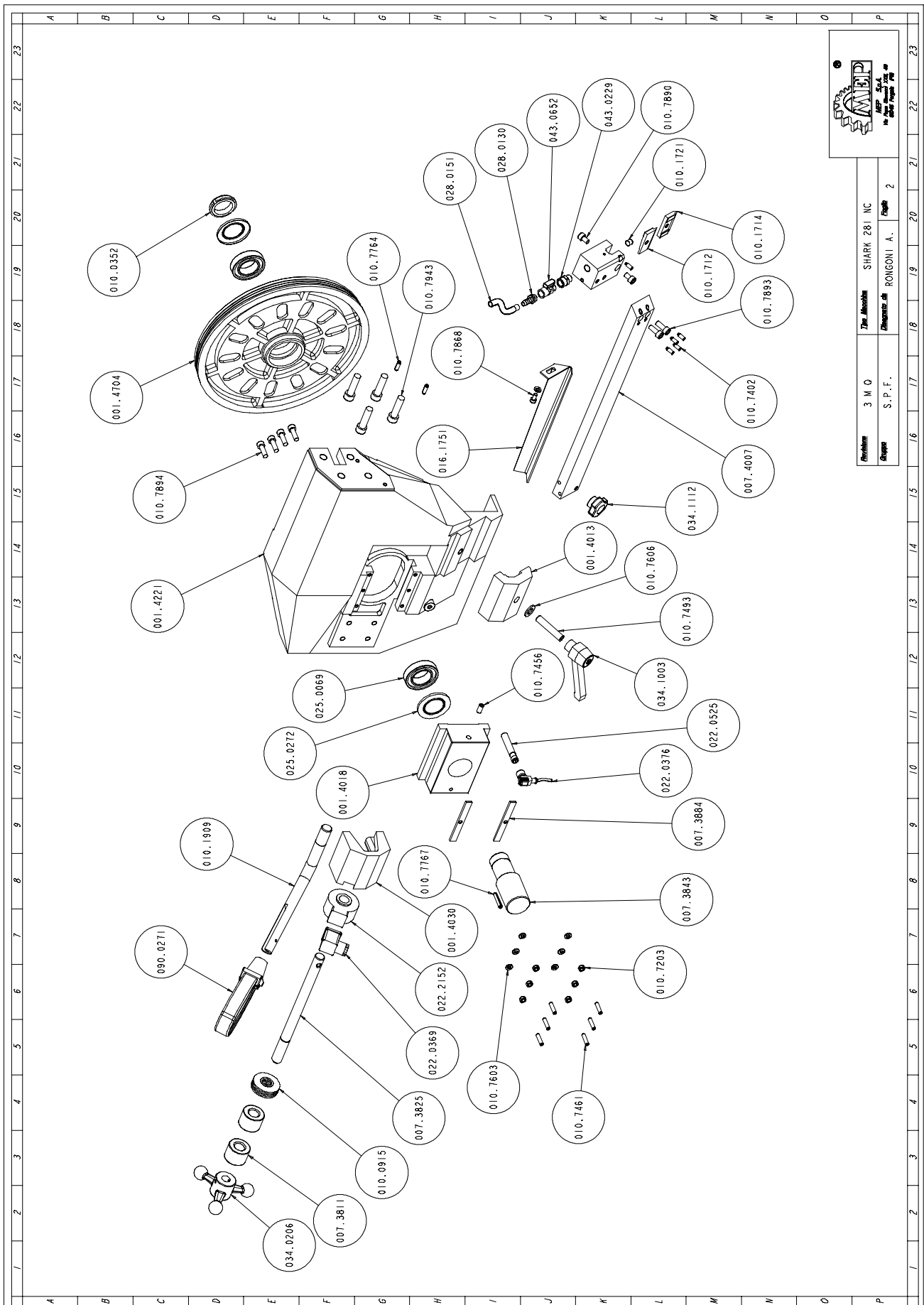

Modello	3 M Q	The Modello	SHARK 281 NC
Disegnato da	S.P.F.	Disegnato da	RONGONI A.
		Foglio	2



Art. NR.	Benaming	M.	Hoeveelheid
001.4013	STAFFA BLOCCAGGIO GUIDA TESTIN	NR	1,000
001.4018	SLITTA TENDILAMA	NR	1,000
001.4030	SUPPORTO TENSIONAMENTO LAMA EL	NR	1,000
001.4221	ARCHETTO SEZIONE PULEGGIA FOLL	NR	1,000
001.4704	PULEGGIA FOLLE SH 270/282 CNC	NR	1,000
007.3811	DISTANZIALE VOLANTINO	NR	2,000
007.3825	PERNO REGISTRO TENSIONAMENTO L	NR	1,000
007.3843	ALBERO VOLANO LIBERO	NR	1,000
007.3884	LARDONE SLITTA TENDILAMA	NR	2,000
007.4007	STAFFA TEST.GUIDALAMA ANT. SH	NR	1,000
010.0352	GHIERA AUTOBLOCCANTE 35X1,5	NR	1,000
010.0915	MOLLA A TAZZA	NR	4,000
010.1712	GUIDALAMA 1 INSERTO ANTERIORE	NR	1,000
010.1714	GUIDALAMA 2 INSERTI ANTERIORE	NR	1,000
010.1721	PREMILAMA	NR	1,000
010.1909	LEVA COMANDO TESTA BT/NOT-AUS	NR	1,000
010.7203	DADO M6	NR	6,000
010.7402	GRANO VCE P.CIL. 6 X 12	NR	5,000
010.7456	GRANO VCE P.CON. 8 X 16	NR	1,000
010.7461	GRANO VCE PUNTA PIANA 6 X 25	NR	6,000
010.7493	GRANO VCE PUNTA PIANA 12 X 60	NR	1,000
010.7603	RONDELLA DIAM. 6	NR	7,000
010.7606	RONDELLA DIAM. 12	NR	1,000
010.7764	SPINA ELASTICA DIAM. 6 X 20	NR	2,000
010.7767	SPINA ELASTICA DIAM. 6 X 35	NR	1,000
010.7868	VITE TCEI 6 X 12	NR	1,000
010.7890	VITE TCEI 8 X 12	NR	2,000
010.7893	VITE TCEI 8 X 20	NR	2,000
010.7894	VITE TCEI 8 X 25	NR	4,000
010.7943	VITE TCEI 12 X 45	NR	4,000
016.1751	PROTEZIONE LAMA ANTERIORE SH	NR	1,000
022.0369	CONNETTORE PER BOBINA U2	NR	1,000
022.0376	CONNETTORE F303N5000 X PROXIMI	NR	1,000
022.0525	SENSORE DI PROSSIMITA	NR	1,000
022.2152	TENSIONATORE ELETTRONICO 02	NR	1,000
025.0069	CUSCINETTO 32007X	NR	2,000
025.0272	ANELLO DI PROTEZIONE NILOS 320	NR	2,000
028.0130	RACCORDO 1/4-9 CL 2601	NR	1,000
028.0151	TUBO PLASTIFICATO 07-11	MT	1,000
034.0206	VOLANTINO TENSIONAMENTO LAMA	NR	1,000
034.1003	LEVA A SCATTO 12 MA	NR	1,000
034.1112	VOLANTINO DIAM.40 M8	NR	1,000
043.0229	RIDUZIONE MF 1/4 - CL 2520	NR	1,000
043.0652	RUBINETTO 1/4 F.M.	NR	1,000
090.0271	IMPUGNATURA COMPLETA TIPO MEP	NR	1,000

Doorsnede aandrijf wiel

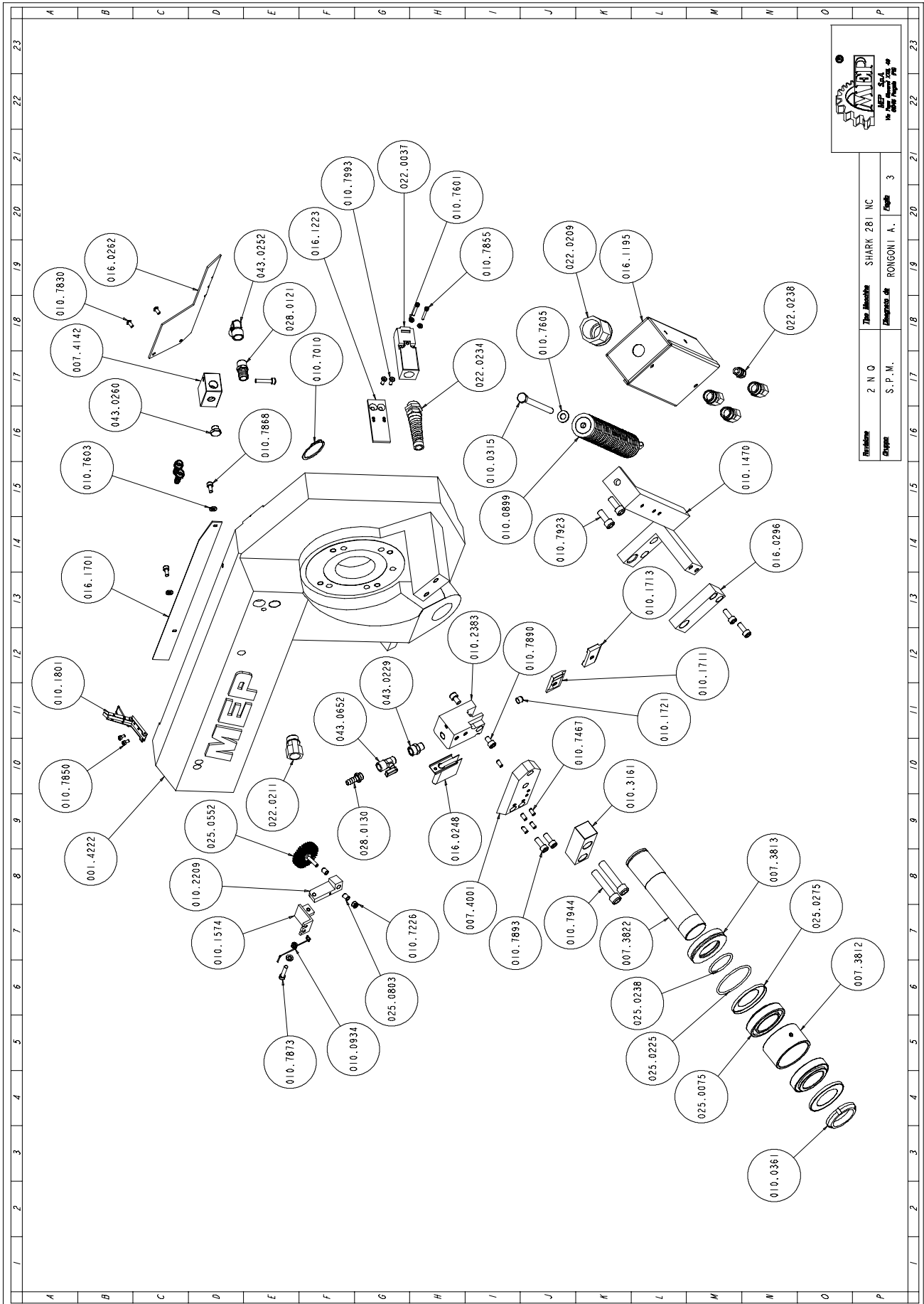

Art. NR.	Benaming	M.	Hoeveelheid
001.4222	ARCHETTO SEZ.PULEGGIA MOTRICE	NR	1,000
007.3812	DISTANZIALE CUSCINETTO SNODO T	NR	1,000
007.3813	DISTANZIALE ARCHETTO	NR	1,000
007.3822	PERNO SUPPORTO SNODO TESTA	NR	1,000
007.4001	STAFFA ANCORAGGIO MOLLA SH 250	NR	1,000
007.4142	SQUADRETTO PER LIQUIDO	NR	1,000
010.0315	VITE 8.8 T.E. 10X140	NR	1,000
010.0361	GHIERA DI PRECISIONE 45X1,5	NR	1,000
010.0899	MOLLA RICHIAMO TESTA SH 260-28	NR	1,000
010.0934	MOLLA X PULILAMA	NR	1,000
010.1470	STAFFA SUPPORTO CILINDRO	NR	1,000
010.1574	STAFFA FIX SPAZZOLA PULILAMA S	NR	1,000
010.1711	GUIDALAMA 1 INSERTO POSTERIORE	NR	1,000
010.1713	GUIDALAMA 2 INSERTI POSTERIORE	NR	1,000
010.1721	PREMILAMA	NR	1,000
010.1801	CHIUSSURA LEVA "D" ZINCATA	NR	1,000
010.2209	PORTASPAZZOLA PULILAMA SH 280	NR	1,000
010.2383	TESTINA GUIDALAMA	NR	1,000
010.3161	BATTUTA FINE CORSA TESTA	NR	1,000
010.7010	ANELLO SEEGER DIAM. 45 US.010.	NR	1,000
010.7226	DADO AUTOBLOCCANTE M6	NR	1,000
010.7467	GRANO VCE PUNTA PIANA 6 X 12	NR	5,000
010.7601	RONDELLA DIAM. 4	NR	2,000
010.7603	RONDELLA DIAM. 6	NR	3,000
010.7605	RONDELLA DIAM. 10	NR	1,000
010.7830	VITE BUTON 5 X 10	NR	2,000
010.7850	VITE TCEI 4 X 8	NR	2,000
010.7855	VITE TCEI 4 X 30	NR	2,000
010.7868	VITE TCEI 6 X 12	NR	2,000
010.7873	VITE TCEI 6 X 30	NR	2,000
010.7890	VITE TCEI 8 X 12	NR	2,000
010.7893	VITE TCEI 8 X 20	NR	4,000
010.7923	VITE TCEI 10 X 25	NR	2,000
010.7944	VITE TCEI 12 X 60	NR	2,000
010.7993	VITE TSPEI 5 X 12	NR	2,000
016.0248	PROTEZIONE NASTRO	NR	1,000
016.0262	PROTEZIONE LAMA POSTERIORE	NR	1,000
016.0296	STAFFA ESTERNA CILINDRO	NR	1,000
016.1195	SCATOLA DI DERIVAZIONE SH NC	NR	1,000
016.1223	PIASTR.FIX INTERR.SICUR.ARCHET	NR	1,000
016.1701	PROTEZIONE CAVI	NR	1,000
022.0037	INTERRUTTORE DI SICUREZZA FR 6	NR	1,000
022.0209	RACCORDO RAPIDO SEM 29 ART.380	NR	1,000
022.0211	RACCORDO RAPIDO SEM PG 13,5	NR	4,000
022.0234	PRESSACORDONE 3246 NERO PG 13,	NR	1,000
022.0238	PRESSACAVO PG 7 BS01	NR	1,000
025.0075	CUSCINETTO 32009X	NR	2,000
025.0225	ANELLO TENUTA OR 171-68,26	NR	1,000
025.0238	ANELLO DI TENUTA OR 44.45X3,53	NR	1,000
025.0275	ANELLO DI PROTEZIONE NILOS 320	NR	2,000
025.0552	SPAZZOLA PULILAMA 6X25 030 GG5	NR	1,000
025.0803	BOCCOLA GRAFITATA L. 10 DIAM.	NR	2,000
028.0121	RACCORDO 3/8-17 CL 2601	NR	1,000
028.0130	RACCORDO 1/4-9 CL 2601	NR	3,000
043.0229	RIDUZIONE MF 1/4 - CL 2520	NR	1,000
043.0252	GOMITO MF 3/8 CL 2020	NR	1,000
043.0260	TAPPO TTE4 1/4 - CL 2611	NR	1,000
043.0652	RUBINETTO 1/4 F.M.	NR	1,000

Afdekking zaagbeugel

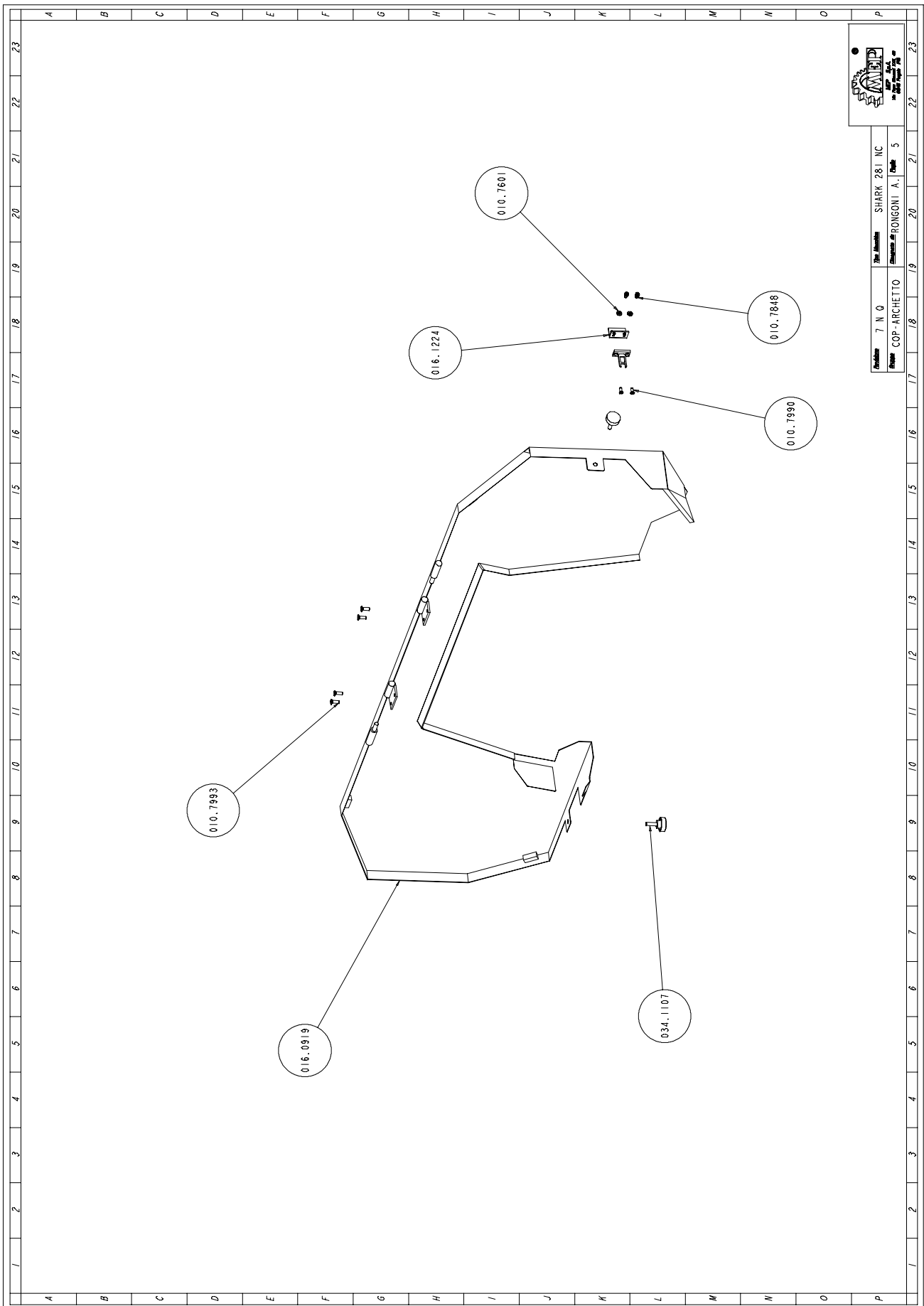

Art. NR.	Benaming	M.	Hoeveelheid
010.7601	RONDELLA DIAM. 4	NR	2,000
010.7850	VITE TCEI 4 X 8	NR	2,000
010.7990	VITE TSPEI 4 X 8	NR	2,000
010.7993	VITE TSPEI 5 X 12	NR	4,000
016.0919	COPERCHIO ARCHETTO SH 280-281-	NR	1,000
016.1224	PIASTR.FIX INTER.SICUR.COPERCH	NR	1,000
034.1107	VOLANTINO DIAM.30 M6 X 20	NR	2,000

Klemgroep

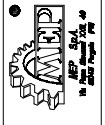
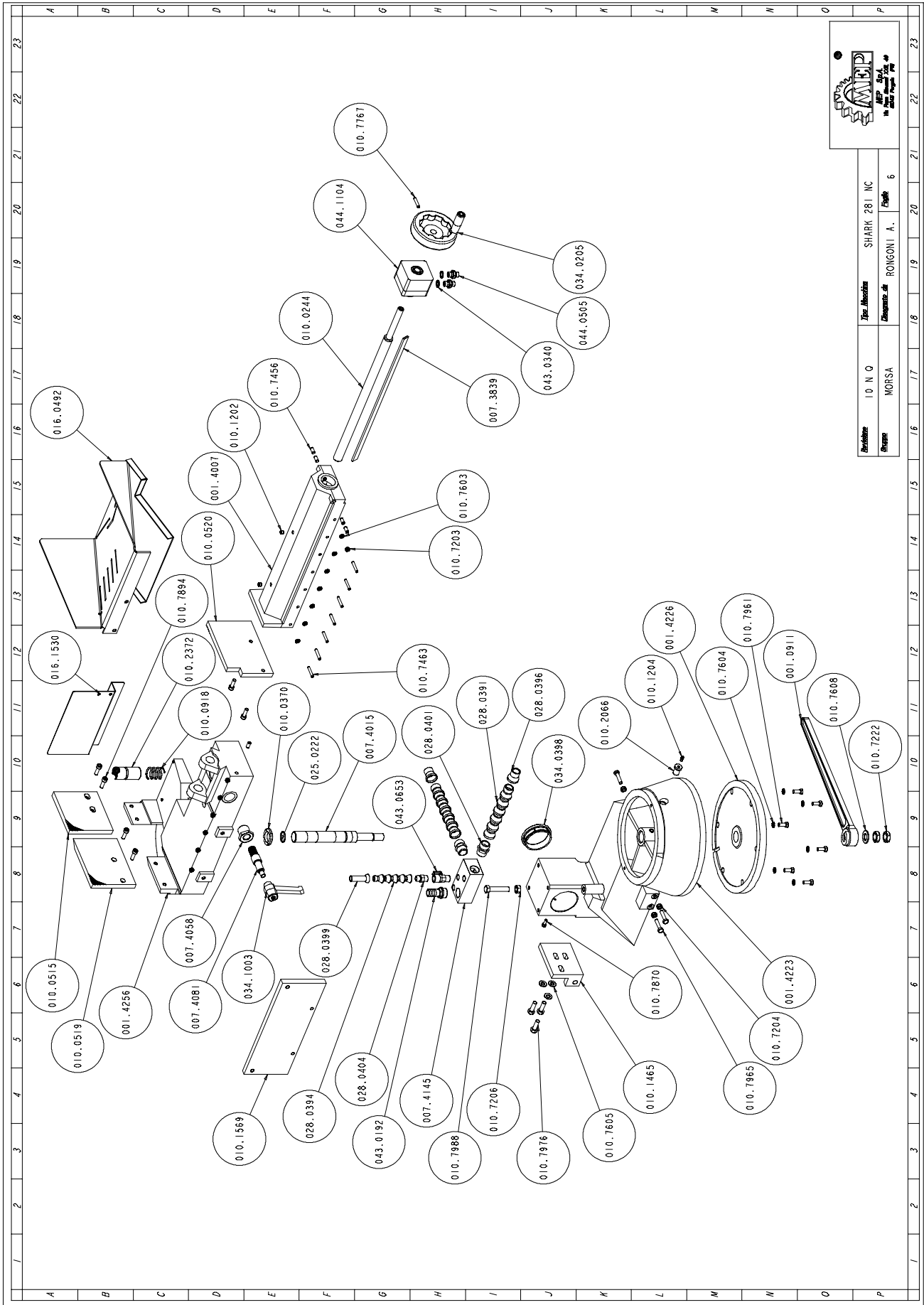

Model	IO N Q	Line/Machine	SHARK 281 NC
Brand	MORSA	Disegnato da	RONGONI A.
		Foglio	6

Art. NR.	Benaming	M.	Hoeveelheid
001.0911	LEVA BLOCCAGGIO MORSA	NR	1,000
001.4007	SCORREVOLE MORSA	NR	1,000
001.4223	PIANO GIREVOLE MORSA SERRAGG.R	NR	1,000
001.4226	DISCO BASAMENTO	NR	1,000
001.4256	MORSA SH 281 NC-EVO MOD	NR	1,000
007.3839	LARDONE MORSA	NR	1,000
007.4015	PERNO DI CENTRO MSR	NR	1,000
007.4058	BOCCOLA ECCENTRICA	NR	1,000
007.4081	PIGNONE SBLOCCAGGIO SCORREVOLE	NR	1,000
007.4145	SQUADR.X LIQUIDO P.G.SH 330 CN	NR	1,000
010.0244	VITE MORSA	NR	1,000
010.0370	GHIERA 5S 30X1,5	NR	1,000
010.0515	GANASCIA MORSA FISSA DESTRA	NR	1,000
010.0519	GANASCIA MORSA SINISTRA	NR	1,000
010.0520	GANASCIA MORSA MOBILE	NR	1,000
010.0918	MOLLA RICHIAMO CHIOCC.VITE MOR	NR	1,000
010.1202	OLIATORE A SFERA DIAM. 8	NR	2,000
010.1204	INGRASSATORE M 6	NR	1,000
010.1465	STAFFA AGGANCIO MOLLA	NR	1,000
010.1569	STAFFA FISSAGGIO ALIMENTATORE	NR	1,000
010.2066	BOCCOLA FISSAGGIO INGRASSATORE	NR	1,000
010.2372	CHIOCCIOLA BRONZO 45° SH 332	NR	1,000
010.7203	DADO M6	NR	7,000
010.7204	DADO M8	NR	3,000
010.7206	DADO M12	NR	1,000
010.7222	DADO M18 BASSO	NR	2,000
010.7456	GRANO VCE P.CON. 8 X 16	NR	5,000
010.7463	GRANO VCE P.CON. 6 X 35	NR	7,000
010.7603	RONDELLA DIAM. 6	NR	7,000
010.7604	RONDELLA DIAM. 8	NR	6,000
010.7605	RONDELLA DIAM. 10	NR	3,000
010.7608	RONDELLA DIAM. 18	NR	1,000
010.7767	SPINA ELASTICA DIAM. 6 X 35	NR	1,000
010.7859	VITE TCEI 5 X 12	NR	4,000
010.7870	VITE TCEI 6 X 16	NR	1,000
010.7894	VITE TCEI 8 X 25	NR	10,000
010.7961	VITE TE 8 X 20	NR	6,000
010.7965	VITE TE 8 X 35	NR	3,000
010.7976	VITE TE 10 X 30	NR	3,000
010.7988	VITE TE 12 X 60	NR	1,000
016.0492	GUIDA SCARICA PEZZI	NR	1,000
016.1530	PARASCHIZZI MORSA SH 281 NC	NR	1,000
025.0203	ANELLO TENUTA 35X25X7	NR	2,000
025.0217	ANELLO TENUTA OR 155-50,80	NR	1,000
025.0222	ANELLO TENUTA OR 3100	NR	1,000
025.0452	RULLI 6X6 AISI 420	NR	1,000
028.0391	TUBO LOOC LINE SPD FP50.10315	MT	2,000
028.0394	TUBO LOOC LINE 1/2 ART. 59861	MT	1,000
028.0396	UGELLO 0 20 SPD FP50.11B50	NR	2,000
028.0399	UGELLO 0 12,7 - 1/2 ART. 59863	NR	1,000
028.0401	RACCORDO 3/4 SPD FP50.17A20	NR	2,000
028.0404	RACCORDO 3/8 NPT LOOC LINE 1/2	NR	1,000
034.0205	VOLANTINO VPRA/125 MR	NR	1,000
034.0398	COPERCHIO SNODO TESTA SH N.T.	NR	1,000
034.1003	LEVA A SCATTO 12 MA	NR	1,000
043.0192	RACCORDO RB 9889 3/4X20	NR	1,000
043.0340	RONDELLA RAME 13X19X1,5-1/4	NR	2,000
043.0653	RUBINETTO M/F 3/8 CL 6310	NR	1,000
044.0505	NIPPLO NP 1/4 IDRAULICO	NR	2,000
044.1104	CILINDRO VOLAMPRESS	NR	1,000

Groep onderstel

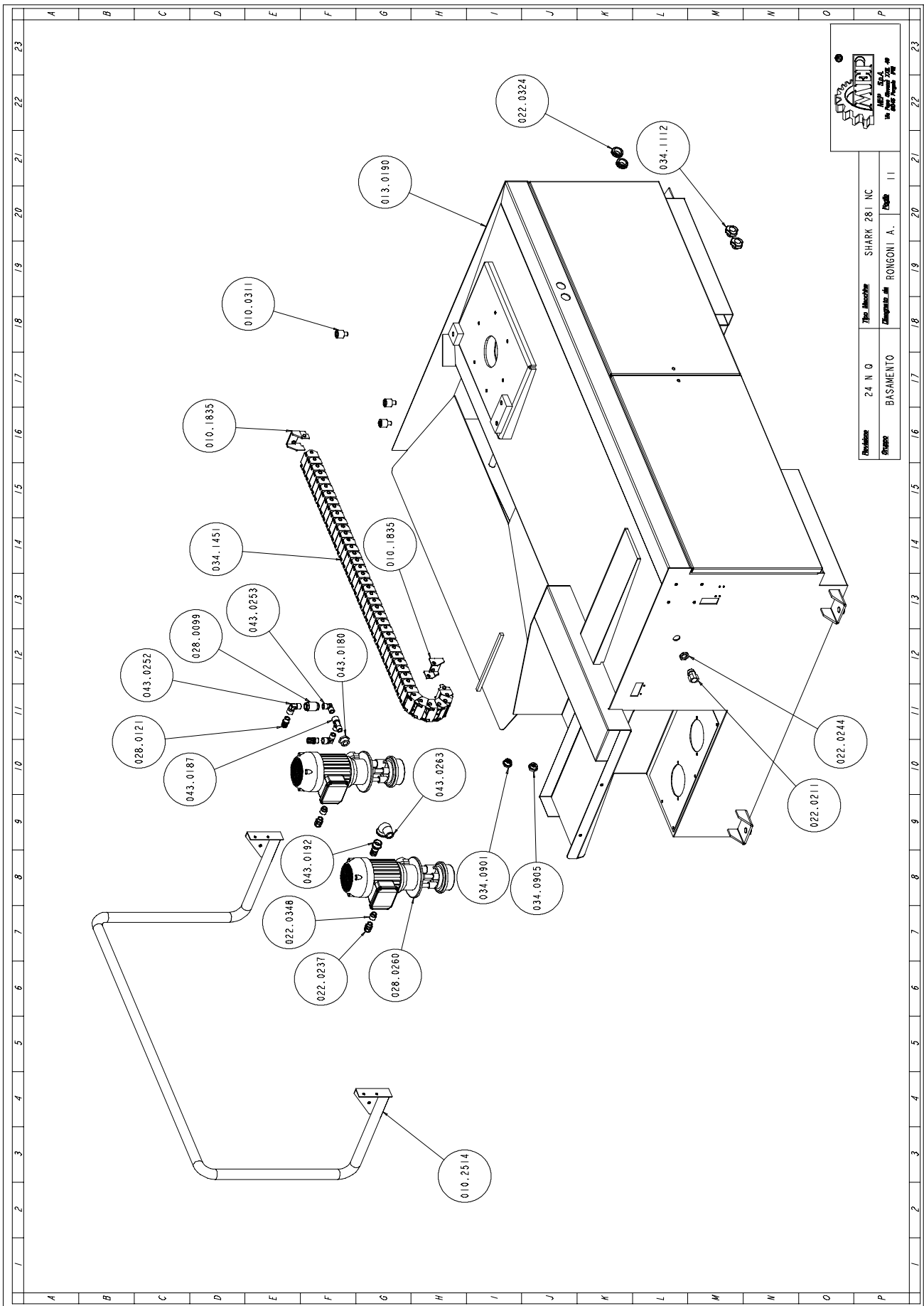

Art. NR.	Benaming	M.	Hoeveelheid
010.0311	VITE TCEI M12X16 BATT.PIANO GI	NR	3,000
010.1835	SET ATTACCHI 117.4.12.P AX-CNC	NR	1,000
010.2514	BARRA DI PROTEZIONE POSTERIORE	NR	1,000
010.7221	DADO M16 BASSO	NR	4,000
013.0190	PIEDISTALLO SH 281 NC	NR	1,000
022.0211	RACCORDO RAPIDO SEM PG 13,5	NR	1,000
022.0244	CONTRODADO 3217B GRIGIO PG 13	NR	1,000
022.0324	PASSACAVI 24 INC.MM.2.5	NR	3,000
028.0099	VALVOLA DI NON RITORNO 3/8"	NR	1,000
028.0121	RACCORDO 3/8-17 CL 2601	NR	2,000
028.0260	ELETTROPOMPA	NR	2,000
034.0901	TAPPO LIVELLO OLIO 1/2 "GAS.	NR	1,000
034.0905	TAPPO OLIO TAO/3 1/2" NERO	NR	1,000
034.1112	VOLANTINO DIAM.40 M8	NR	2,000
034.1451	CATENA PORTACAVI E17.04.63.0	MT	1,000
043.0180	RIDUZIONE M 3/4-F 3/8	NR	1,000
043.0187	ATTACCO A T FMM 3/8 CL 2050	NR	1,000
043.0192	RACCORDO RB 9889 3/4X20	NR	1,000
043.0252	GOMITO MF 3/8 CL 2020	NR	2,000
043.0253	GOMITO M.M.3/8 CL 2010	NR	1,000
043.0263	RACCORDO A GOMITO M/F ZINCATO	NR	1,000

Handvat

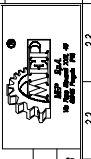
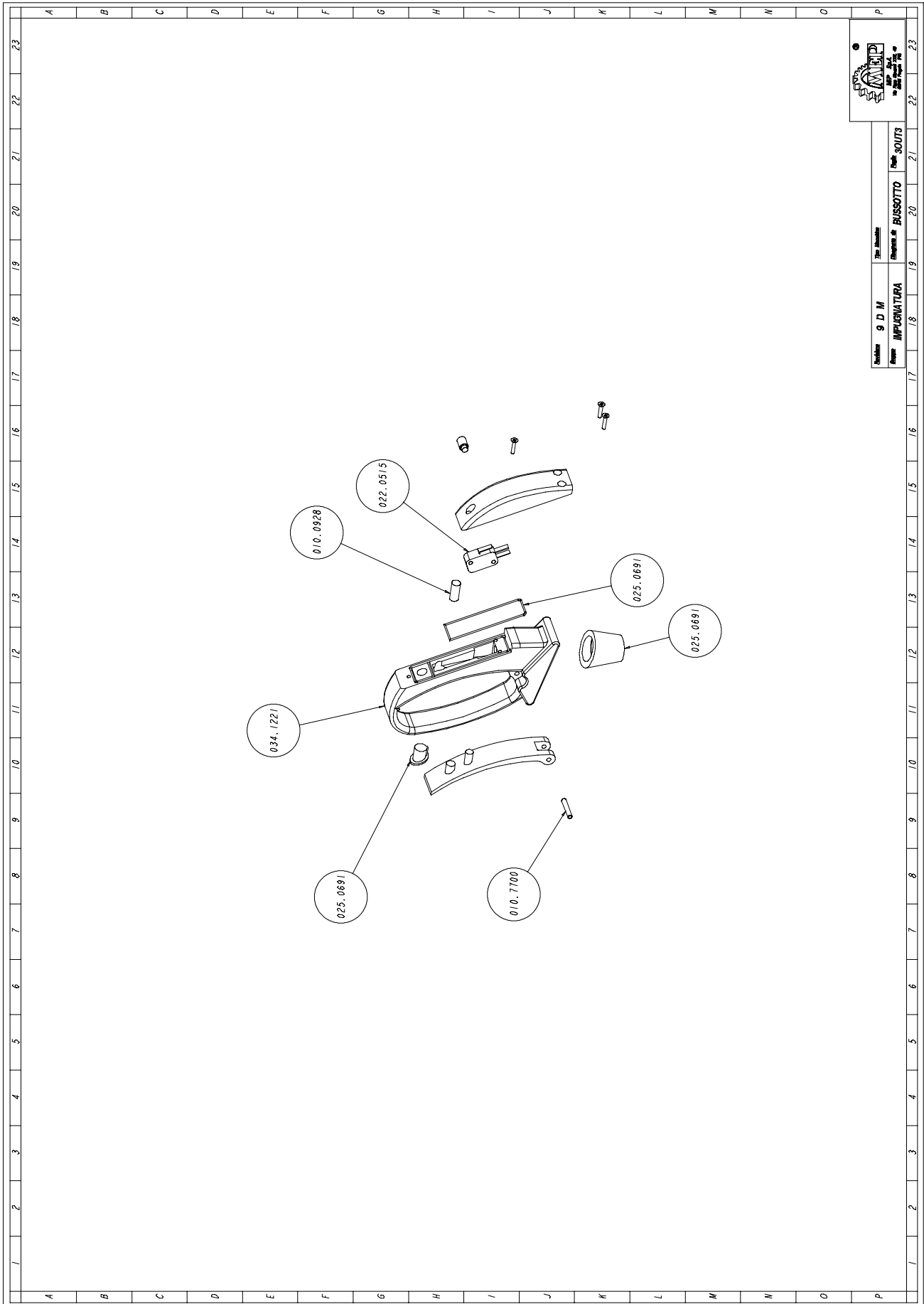

Tipo Attrezzo
9 D M
 Gruppo **IMPUGNATURA**
 Design di **BUSSOTTO** Serie **SHOOTS**

Art. NR.	Benaming	M.	Hoeveelheid
010.0928	MOLLA X IMPUGNATURA	NR	1,000
010.7409	GRANO VCE P.CIL. 8 X 10	NR	1,000
010.7700	SPINA CILINDRICA DIAM. 4 X 24	NR	1,000
010.7800	VITE AUTOFILETTANTE 2,9 X 15	NR	3,000
022.0515	MICROINTERRUPTORE V-21-1C6	NR	1,000
025.0691	SERIE GUARNIZIONI X IMPUGNATURA MEP	NR	1,000
034.1221	IMPUGNATURA DIS. MEP	NR	1,000

Veiligheidsstang-voor groep

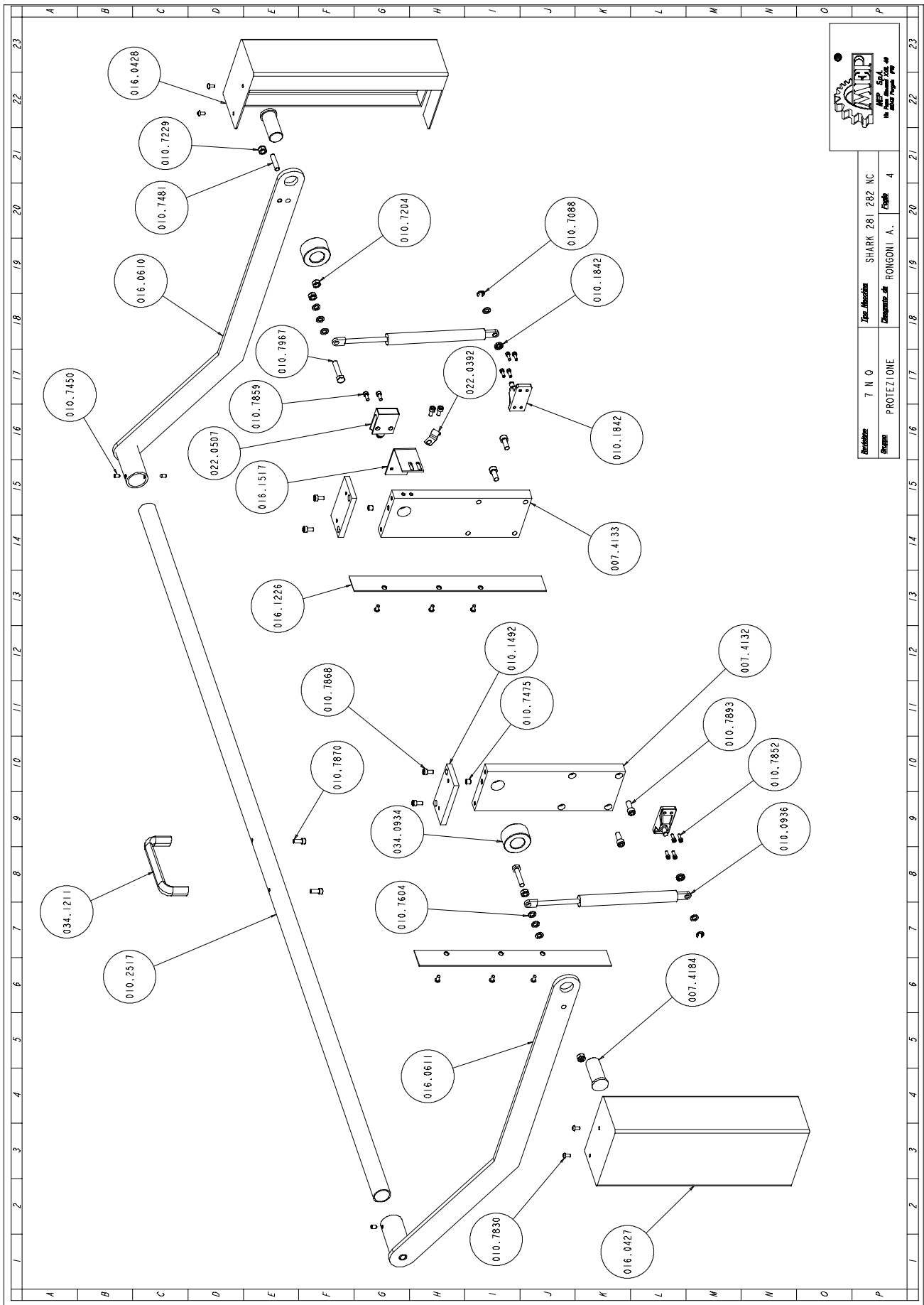

		Tipo/Macchina SHARK 281 282 NC
		Numero di RONGONI A.
Revisione 7 N O	PROTEZIONE	Foglio 4

Art. NR.	Benaming	M.	Hoeveelheid
007.4132	SUPPORTO DX BARRA PROTEZIONE	NR	1,000
007.4133	SUPPORTO SX BARRA PROTEZIONE	NR	1,000
007.4184	PERNO BARRA PROTEZIONE SH 330-	NR	2,000
010.0936	MOLLA GAS	NR	2,000
010.1492	STAFFA FIX BARRA PROTEZIONE	NR	2,000
010.1842	SUPPORTO MASCHIO X MOLLA A GAS	NR	4,000
010.2517	BARRA DI PROTEZIONE ANTERIORE	NR	1,000
010.7088	ANELLO ELASTICO DI ARRESTO AD	NR	2,000
010.7204	DADO M8	NR	3,000
010.7229	DADO AUTOBLOCCANTE M8	NR	2,000
010.7450	GRANO VCE P.CIL. 6 X 6	NR	4,000
010.7475	GRANO VCE P.PIANA 8 X 8	NR	2,000
010.7481	GRANO VCE PUNTA PIANA 8 X 35	NR	1,000
010.7604	RONDELLA DIAM. 8	NR	8,000
010.7830	VITE BUTON 5 X 10	NR	10,000
010.7852	VITE TCEI 4 X 12	NR	8,000
010.7859	VITE TCEI 5 X 12	NR	2,000
010.7868	VITE TCEI 6 X 12	NR	6,000
010.7870	VITE TCEI 6 X 16	NR	2,000
010.7893	VITE TCEI 8 X 20	NR	4,000
010.7967	VITE TE 8 X 40	NR	2,000
016.0427	PROTEZIONE DX BARRA ALIMENTORE	NR	1,000
016.0428	PROTEZIONE SX BARRA ALIMENTORE	NR	1,000
016.0610	SUPPORTO BARRA DI PROTEZIONE S	NR	1,000
016.0611	SUPPORTO BARRA DI PROTEZIONE D	NR	1,000
016.1226	PIASTRINO CHIUSURA PROTEZ.DX-S	NR	2,000
016.1517	STAFFA FIX F.C.BARRA PROTEZION	NR	1,000
022.0392	GRAFFETTE IN ACCIAIO DM 10-11	NR	1,000
022.0507	FINECORSO D4C-1G02 1M	NR	1,000
034.0934	TAPPO DISTANZ.BARRA PROTEZIONE	NR	2,000
034.1211	MANIGLIA GN-565-20-128.SW	NR	1,000

Invoerwagen groep

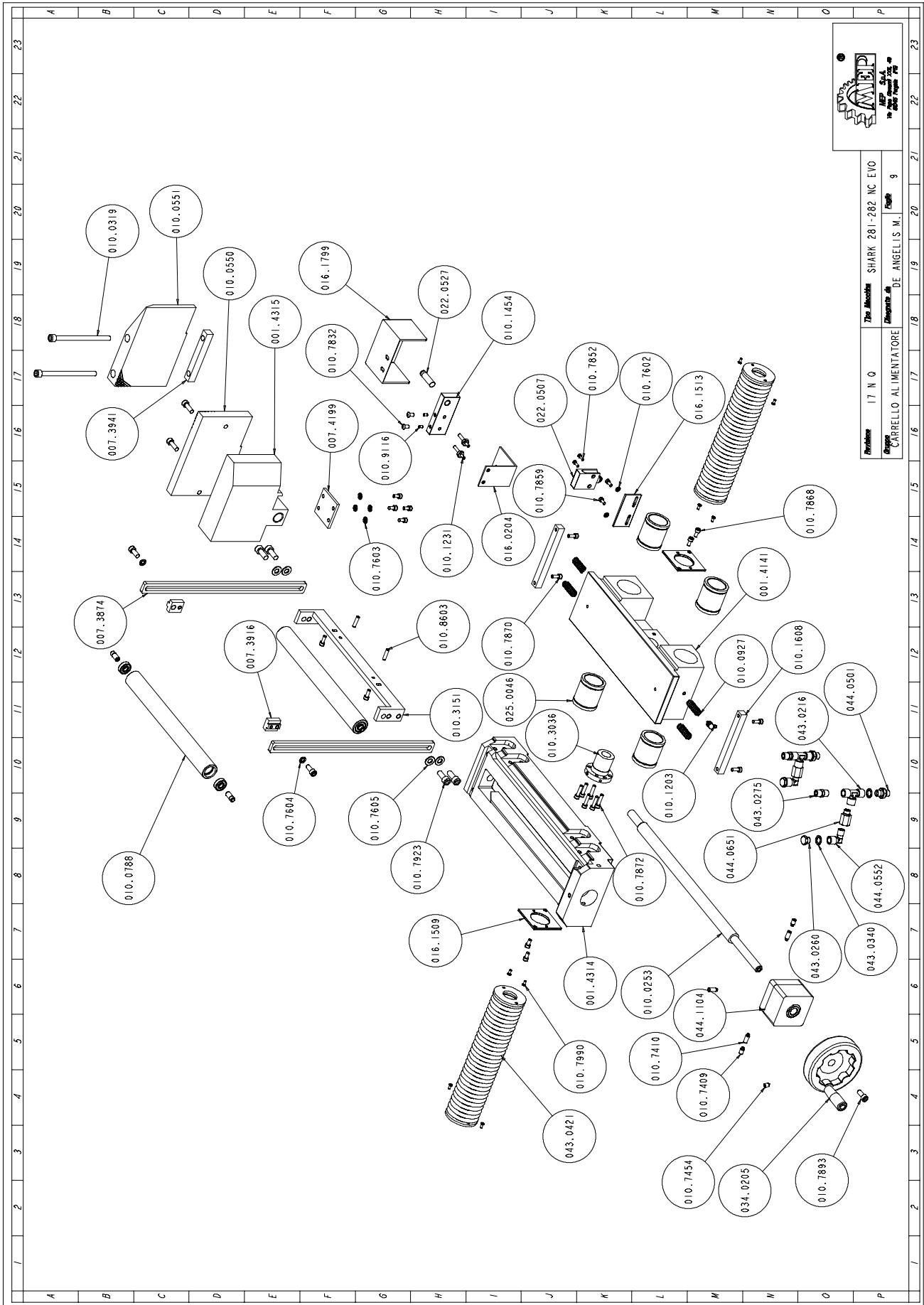

Art. NR.	Benaming	M.	Hoeveelheid
001.4141	CARRELLO ALIMENTATORE SHARK NC	NR	1,000
001.4314	MORSA ALIMENTATORE 60°	NR	1,000
001.4315	CHIOCC.MORSA ALIM.RIDUZIONE SF	NR	1,000
007.3874	SUPPORTO RULLO PREMIBARRA	NR	2,000
007.3916	TASSELLO FIX RULLO SUPPLEMENTA	NR	2,000
007.3941	CHIAVETTA X GAN.FISSA ALIMENTA	NR	1,000
007.4199	PIASTR.FIX SCORR.MORSA ALIMENT	NR	1,000
010.0253	VITE MORSA ALIM.567X24 SH FIL.	NR	1,000
010.0319	VITE 8.8 TCEI 10X140 TI	NR	2,000
010.0550	GANASCIA MOBILE ALIM. SH 282 C	NR	1,000
010.0551	GANASCIA FISSA ALIM. SH 282 CN	NR	1,000
010.0782	RULLO ALIMENTATORE	NR	2,000
010.0788	RULLO 0 35 COMPLETO	NR	2,000
010.0927	MOLLA CARRELLO ALIMENTATORE	NR	4,000
010.1203	OLIATORE A 90° 6X1	NR	1,000
010.1231	VITE FIX STAFFA F.C. ALIMENT.	NR	2,000
010.1454	STAFFA FISSAGGIO FINE CORSA AL	NR	1,000
010.1608	TASSELLO MORSA BASCULANTE ALIM	NR	2,000
010.1660	PERNO X RULLO ALIMENTATORE	NR	4,000
010.3036	CHIOCCIOLA R2010T2FSI C7A10UC1	NR	1,000
010.3151	SUPPORTO RULLO MORSA ALIMENTAT	NR	1,000
010.7409	GRANO VCE P.CIL. 8 X 10	NR	2,000
010.7410	GRANO VCE P.CIL. 8 X 16	NR	3,000
010.7454	GRANO VCE P.CON. 8 X 8	NR	1,000
010.7602	RONDELLA DIAM. 5	NR	2,000
010.7603	RONDELLA DIAM. 6	NR	4,000
010.7604	RONDELLA DIAM. 8	NR	2,000
010.7605	RONDELLA DIAM. 10	NR	4,000
010.7832	VITE BUTON 6 X 12	NR	2,000
010.7852	VITE TCEI 4 X 12	NR	2,000
010.7859	VITE TCEI 5 X 12	NR	6,000
010.7868	VITE TCEI 6 X 12	NR	8,000
010.7870	VITE TCEI 6 X 16	NR	6,000
010.7872	VITE TCEI 6 X 25	NR	6,000
010.7893	VITE TCEI 8 X 20	NR	3,000
010.7894	VITE TCEI 8 X 25	NR	6,000
010.7923	VITE TCEI 10 X 25	NR	4,000
010.7990	VITE TSPEI 4 X 8	NR	8,000
010.8603	SPINA CILINDRICA DIAM. 6 X 25	NR	2,000
010.9116	GRANO VCE PUNTA PIANA 5 X 8	NR	2,000
016.0204	SUPPORTO CATENA ALIMENTATORE	NR	1,000
016.1509	STAFFA FIX SOFFIETTO CIRCOLARE	NR	2,000
016.1513	STAFFA FIX MICROINTERRUTTORE	NR	1,000
016.1799	PROTEZIONE FINE CORSA ALIMENTA	NR	1,000
022.0507	FINECORSO D4C-1G02 1M	NR	1,000
022.0527	SENSORE DI PROSSIMITA' PNP-NO	NR	1,000
025.0046	MANICOTTO A SFERA 0658.040.00	NR	4,000
025.0060	CUSCINETTO 6000 2Z	NR	4,000
025.0203	ANELLO TENUTA 35X25X7	NR	2,000
025.0217	ANELLO TENUTA OR 155-50,80	NR	1,000
025.0452	RULLI 6X6 AISI 420	NR	1,000
034.0205	VOLANTINO VPRA/125 MR	NR	1,000
043.0216	RACCORDO A "T" FFF 1/4 CL 2003	NR	2,000
043.0260	TAPPO TTE4 1/4 - CL 2611	NR	2,000
043.0275	NIPPLO CONICO A2-1/4 - CL 2500	NR	2,000
043.0340	RONDELLA RAME 13X19X1,5-1/4	NR	4,000
043.0421	SOFFIETTO CIRCOLARE X ALIMENTA	NR	2,000
044.0501	NIPPLO NP 1/4 IDRAULICO	NR	2,000
044.0552	RACCORDO A GOMITO IDRAULICO MF	NR	2,000
044.0651	PROLUNGA 1/4" M.F. ES.20MM.	NR	2,000
044.1104	CILINDRO VOLAMPRESS	NR	1,000

Aanvoerrollenbaan groep

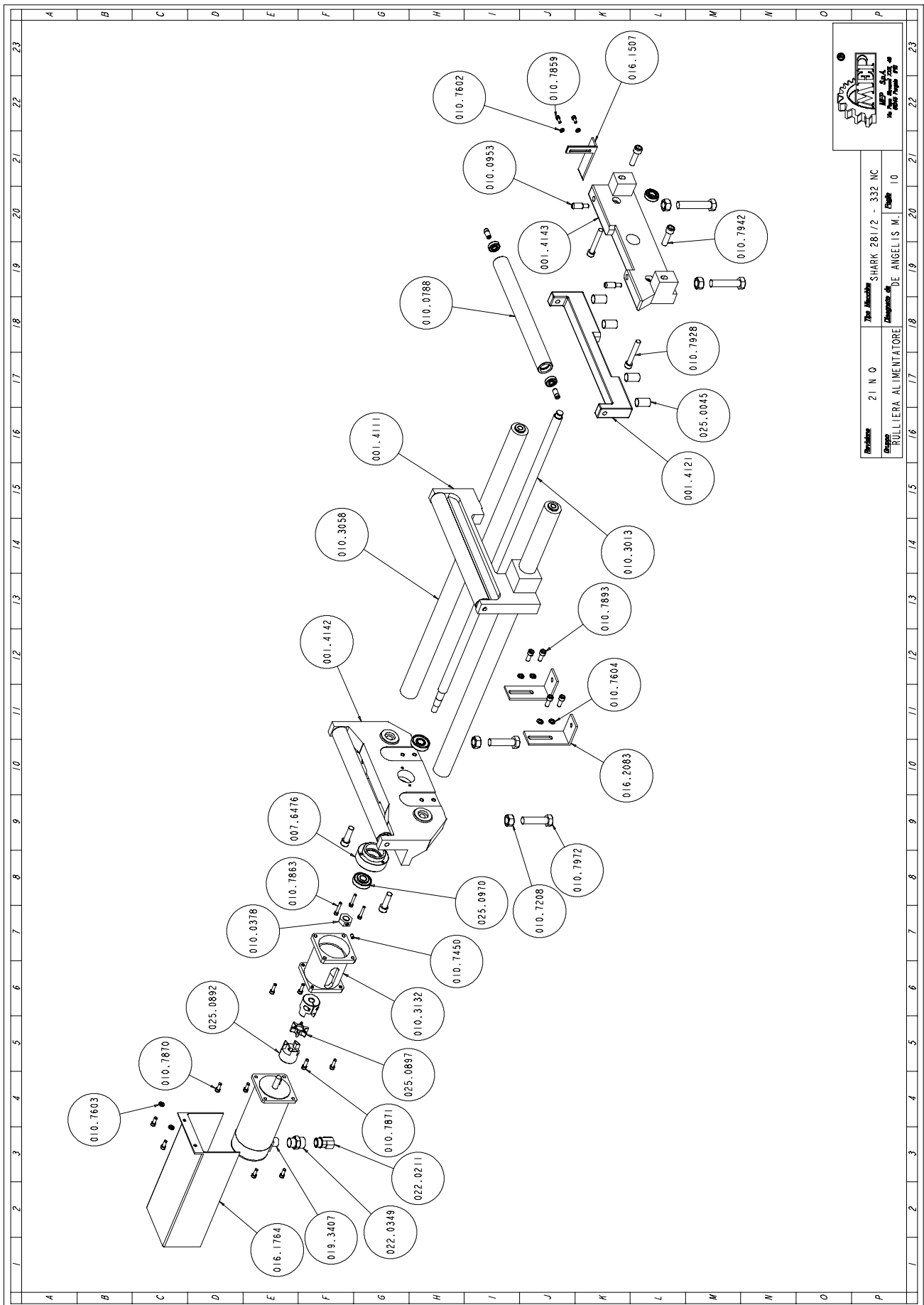

Art. NR.	Benaming	M.	Hoeveelheid
001.4111	SUPPORTO RULLO LIBERO ALIMENTA	NR	1,000
001.4121	STAFFA ANT. PARTE SUP. ALIMENT	NR	1,000
001.4142	STAFFA POSTERIORE ALIMENTATORE	NR	1,000
001.4143	STAFFA ANTERIORE INFERIORE ALI	NR	1,000
007.6476	MANICOTTO VITE RICIRCOLO ALIME	NR	1,000
010.0378	GHIERA FISSAGGIO VITE RICIRCOL	NR	1,000
010.0782	RULLO ALIMENTATORE	NR	3,000
010.0788	RULLO 0 35 COMPLETO	NR	3,000
010.0953	PERNO DI CENTRAGGIO TESTATA AN	NR	2,000
010.1660	PERNO X RULLO ALIMENTATORE	NR	6,000
010.3013	VITE RULLATA R2010/1000/1000 C	NR	1,000
010.3058	GUIDA CARRELLO ALIMENTATORE 0	NR	2,000
010.3132	SUPPORTO MOTORE P/P ALIMENTATO	NR	1,000
010.7208	DADO M16	NR	4,000
010.7450	GRANO VCE P.CIL. 6 X 6	NR	1,000
010.7602	RONDELLA DIAM. 5	NR	2,000
010.7603	RONDELLA DIAM. 6	NR	2,000
010.7604	RONDELLA DIAM. 8	NR	4,000
010.7859	VITE TCEI 5 X 12	NR	2,000
010.7863	VITE TCEI 5 X 30	NR	3,000
010.7870	VITE TCEI 6 X 16	NR	6,000
010.7871	VITE TCEI 6 X 20	NR	4,000
010.7893	VITE TCEI 8 X 20	NR	4,000
010.7928	VITE TCEI 10 X 70	NR	2,000
010.7942	VITE TCEI 12 X 40	NR	4,000
010.7972	VITE TE 16X60	NR	2,000
016.1507	STAFFA COMANDO MICROINTERRUTTO	NR	1,000
016.1764	PROTEZIONE MOTORE ALIMENT. SH	NR	1,000
016.2083	STAFFA FIX ALIMENTATORE	NR	2,000
019.3407	MOTORE P/P FL86STH156-5708AL	NR	1,000
025.0045	MANICOTTO A RIC.SFERE LBBS12-2	NR	4,000
025.0060	CUSCINETTO 6000 2Z	NR	6,000
025.0892	MOZZO 1A RTX 19 AL-H-12-2.0 AR	NR	2,000
025.0897	STELLA RTX 19-98 GS ART.130515	NR	1,000
025.0970	CUSCINETTO 30302J2	NR	2,000

Idraulische aggregaten

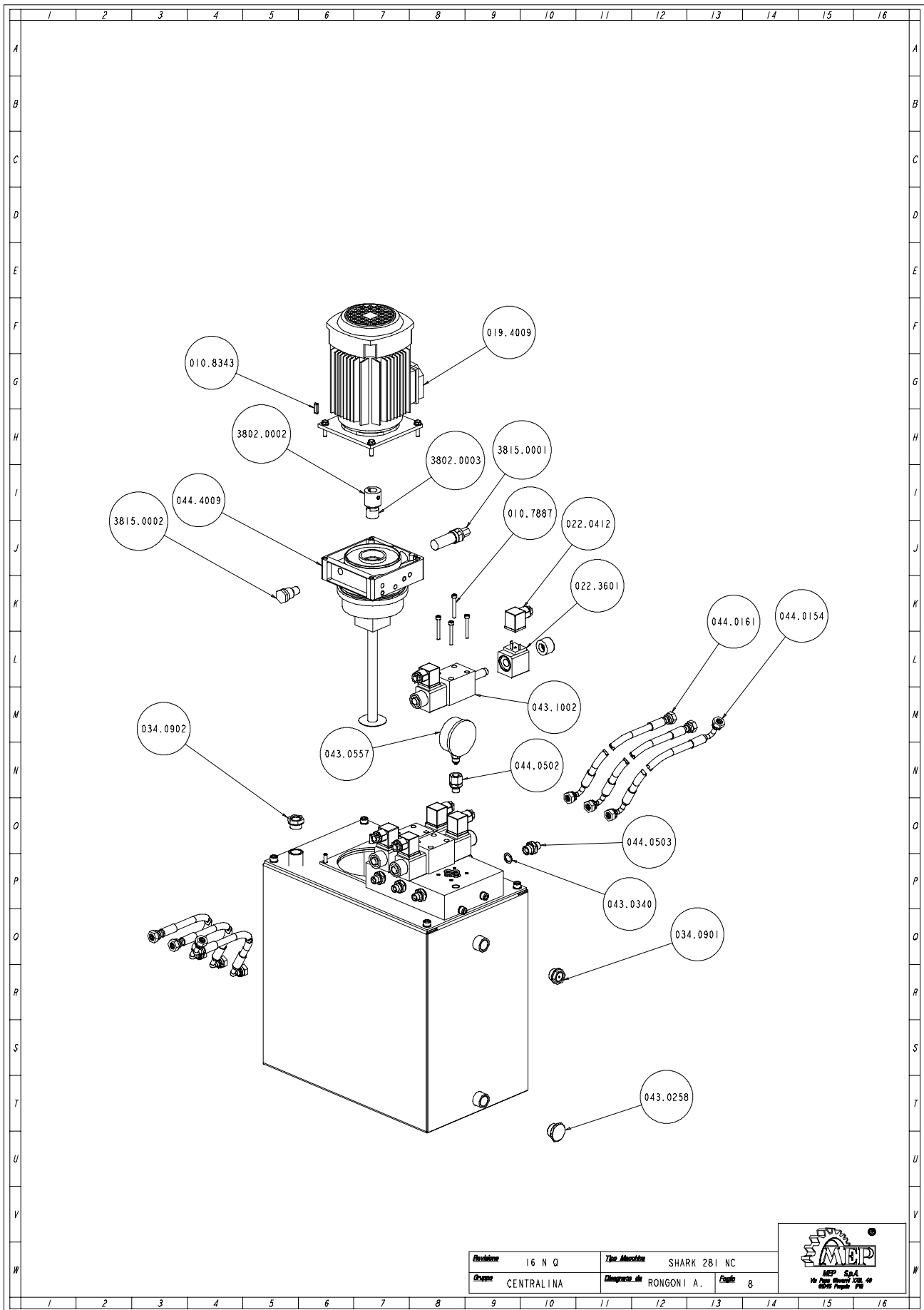

Partname	16 N Q	The Machine	SHARK 281 NC
Gruppo	CENTRALINA	Disegnato da	RONGONI A. Finito 8



Art. NR.	Benaming	M.	Hoeveelheid
010.7887	VITE TCEI 5 X 40	NR	12,000
010.8343	CHIAVETTA 5 X 5 X 20	NR	1,000
019.4009	MOTORE CENTRAL.HP 1 C80 B14 V.	NR	1,000
022.0412	CONNETT.BOBINA VALV. RIGENERAT	NR	6,000
022.3601	BOBINA 24V. DC 19.02.741 X ELE	NR	6,000
034.0901	TAPPO LIVELLO OLIO 1/2 "GAS.	NR	1,000
034.0902	TAPPO OLIO SFP 1/2" ROSSO	NR	1,000
043.0258	TAPPO 3/4 CL 3020	NR	1,000
043.0340	RONDELLA RAME 13X19X1,5- 1/4	NR	6,000
043.0557	MANOMETRO DIAM.60 WIKA	NR	1,000
043.1002	ELETTROVALVOLA	NR	3,000
044.0154	TUBO CENTRALINA MM 3500 2X90°	NR	2,000
044.0161	TUBO CENTRALINA IDRAULICA MM.	NR	4,000
044.0502	NIPPLO IDRAULICO GIREVOLE GMF	NR	1,000
044.0503	NIPPLO IDRAULICO M 3/8-M 1/4	NR	6,000
044.1263	VALVOLA DI MASSIMA PRESSIONE	NR	1,000
044.4554	TAPPO VALVOLA	NR	1,000
044.4636	GIUNTO COLLEGAMENTO LATO MOTOR	NR	1,000
044.4637	GIUNTO COLLEGAMENTO LATO POMPA	NR	1,000

Cilindergroep

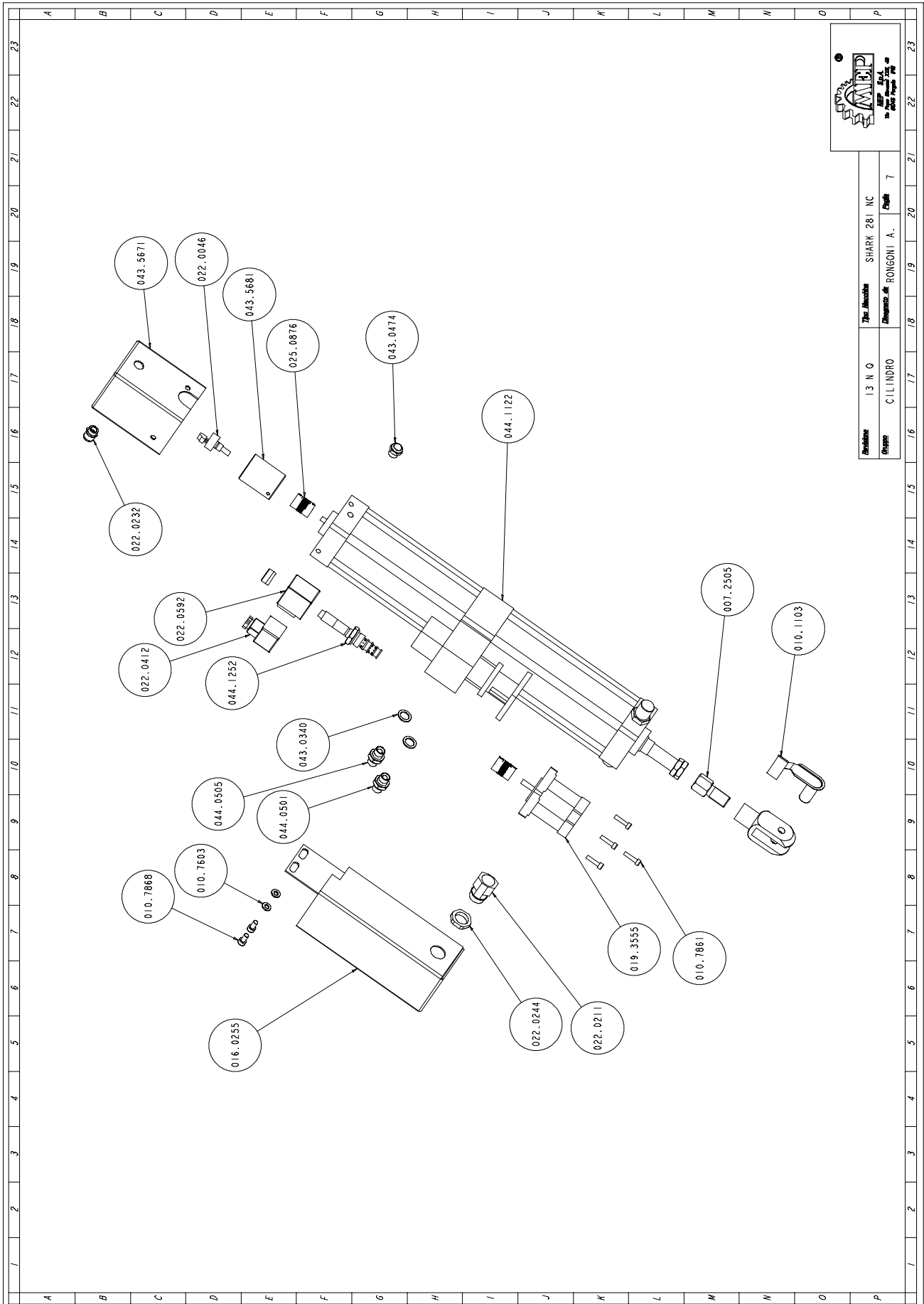

Art. NR.	Benaming	M.	Hoeveelheid
007.2505	PROLUNGA FORCELLA	NR	1,000
010.1103	FORCELLA 16 X 1,5	NR	1,000
010.7603	RONDELLA DIAM. 6	NR	2,000
010.7861	VITE TCEI 5 X 20	NR	4,000
010.7868	VITE TCEI 6 X 12	NR	2,000
016.0255	PROTEZIONE CILINDRO	NR	1,000
019.3555	MOTORE F257STH76-2804 X CILIND	NR	1,000
022.0046	POTENZIOMETRO 6639S-001-202	NR	1,000
022.0211	RACCORDO RAPIDO SEM PG 13,5	NR	1,000
022.0232	PRESSACAVO IN OTTONE 1/4 BM 24	NR	1,000
022.0244	CONTRODADO 3217B GRIGIO PG 13	NR	1,000
022.0412	CONNETT.BOBINA VALV. RIGENERAT	NR	1,000
022.0592	BOBINA VALV. RIGENERATRICE CIL	NR	1,000
025.0876	GIUNTO WA 6-6 MM.28 X CILINDRO	NR	2,000
043.0340	RONDELLA RAME 13X19X1,5- 1/4	NR	2,000
043.0474	SILENZIATORE IN OTTONE 1/4"	NR	1,000
043.5671	PROTEZIONE POTENZIOMETRO CILIN	NR	1,000
043.5681	SUPPORTO POTENZIOMETRO CILINDR	NR	1,000
044.0501	NIPPLO NP 1/4 IDRAULICO	NR	1,000
044.0505	NIPPLO NP 1/4 IDRAULICO	NR	1,000
044.1122	CILINDRO IDRAULICO	NR	1,000
044.1252	VALVOLA RIGENERATRICE CILINDRO	NR	1,000