

Explosietekeningen

In het nu volgende deel zijn de explosietekeningen van de machine opgenomen. De tekeningen met hun volledige details kunnen helpen de machine beter te leren kennen.

Motorgroep

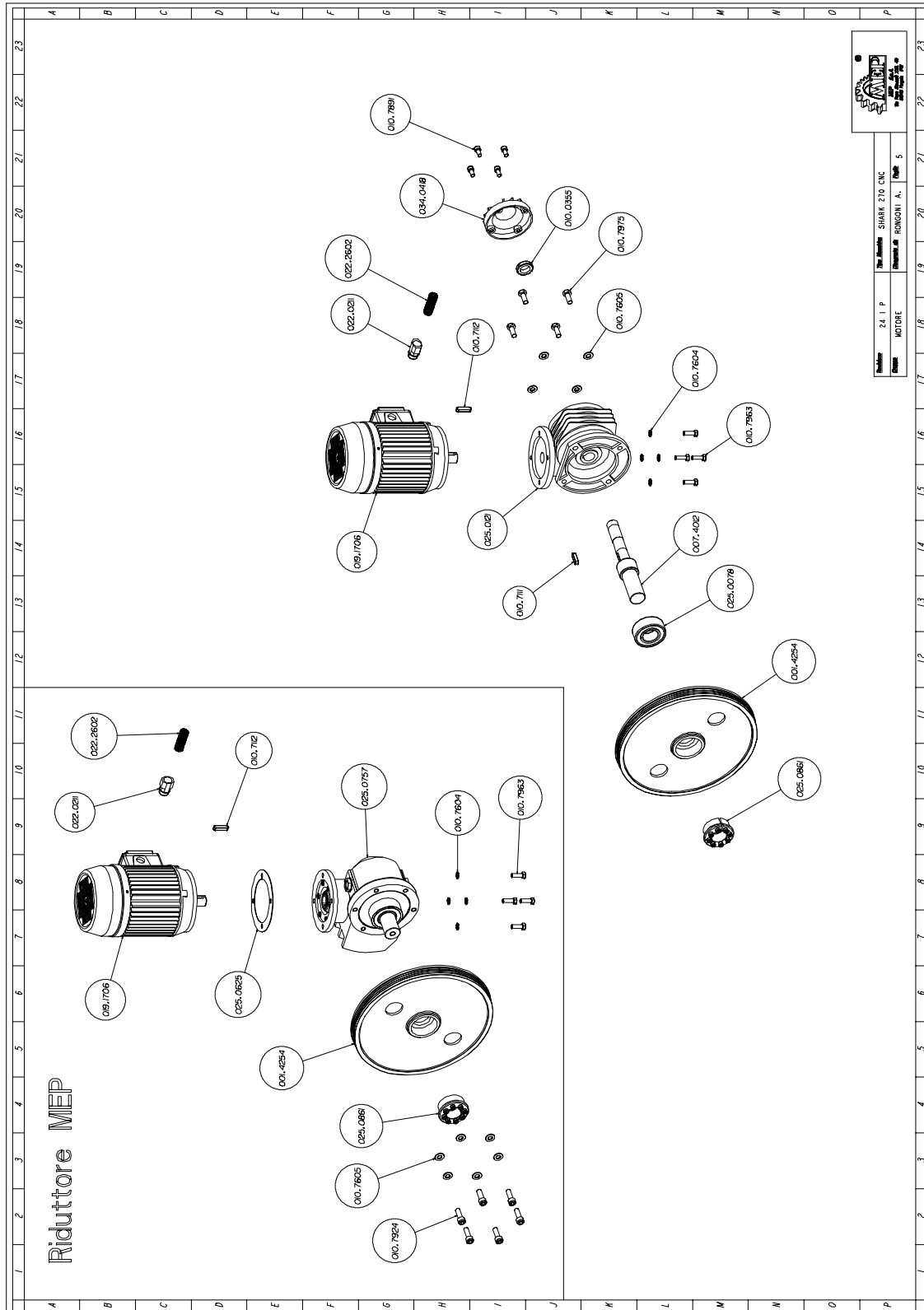

Art. NR.	Benaming	M.	Hoeveelheid
001.4254	PULEGGIA MOTRICE	NR	1,000
007.4012	ALBERO RIDUTTORE	NR	1,000
010.0355	GHIERA AUTOBLOCCANTE 25X1,5	NR	1,000
010.7111	CHIAVETTA 8 X 7 X 32	NR	1,000
010.7112	CHIAVETTA 8 X 7 X 35	NR	1,000
010.7604	RONDELLA DIAM. 8	NR	4,000
010.7605	RONDELLA DIAM. 10	NR	4,000
010.7871	VITE TCEI 6 X 20	NR	8,000
010.7891	VITE TCEI 8 X 16	NR	4,000
010.7963	VITE TE 8 X 25	NR	4,000
010.7975	VITE TE 10 X 25	NR	4,000
019.1706	HP 2/2,5 2/4P V.380 B14 FC90L	NR	1,000
022.0211	RACCORDO RAPIDO SEM PG 13,5	NR	1,000
022.2602	GUAINA POLIFLEX NW 14- 1200143	MT	1,000
025.0078	CUSCINETTO 3207A-2RS1TN9	NR	1,000
025.0121	RIDUTTORE MVF 63 FCO 1A38 90 B14	NR	1,000
025.0861	CALETTATORE 0 35X60	NR	1,000
034.0418	COPERCHIO RIDUTTORE	NR	1,000

Doorsnede loopwiel

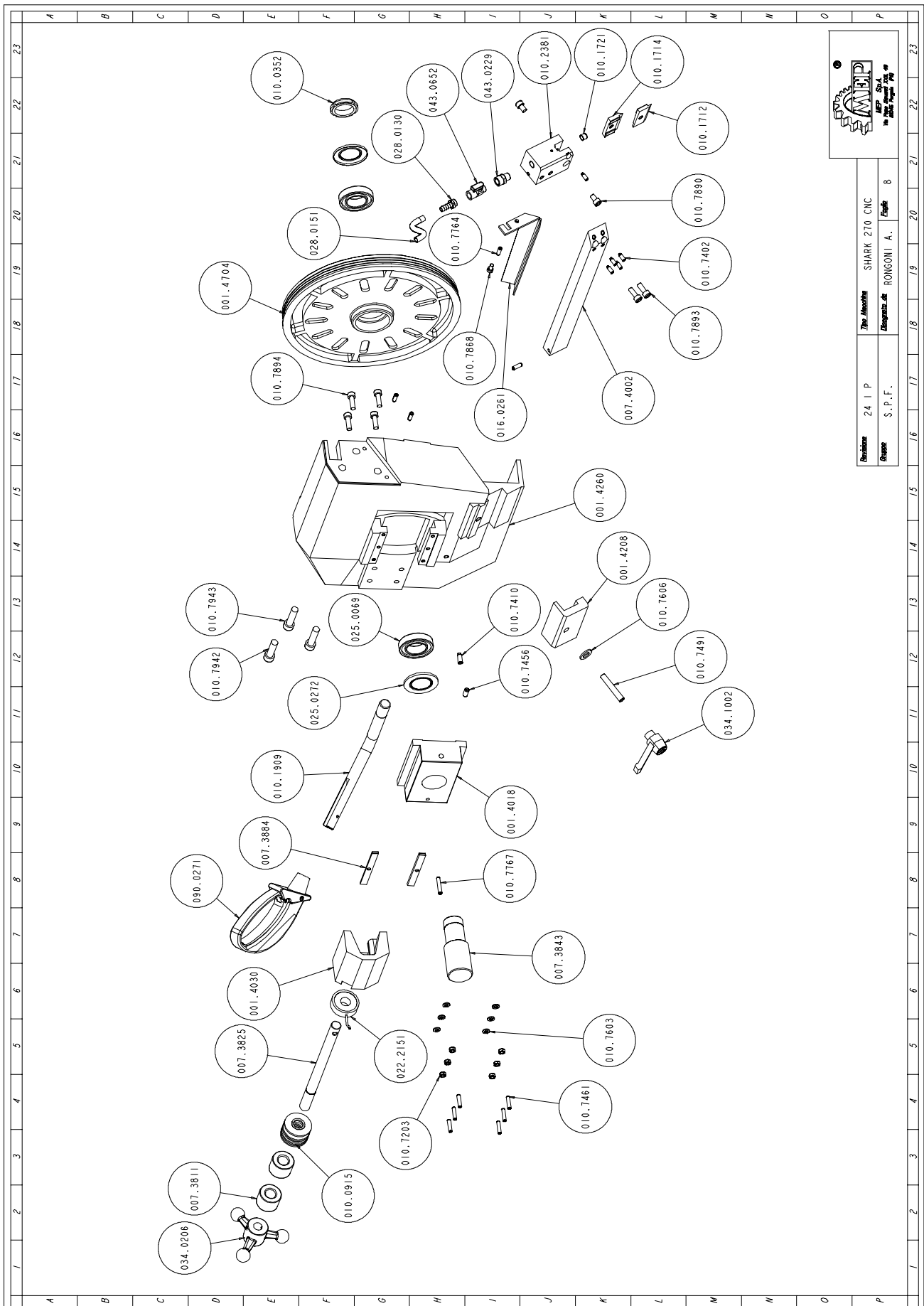

Revisione	24 I P	The Machine	SHARK 270 CNC
Disegno	S. P. F.	Disegnato da	RONGONI A. Foglio 8

Art. NR.	Benaming	M.	Hoeveelheid
001.4018	SLITTA TENDILAMA	NR	1,000
001.4030	SUPPORTO TENSIONAMENTO LAMA ELETTR.	NR	1,000
001.4208	STAFFA BLOCCAGGIO GIREVOLE TESTA	NR	1,000
001.4260	ARCHETTO SEZIONE PULEGGIA FOLLE	NR	1,000
001.4704	PULEGGIA FOLLE SH 270 CNC	NR	1,000
007.3811	DISTANZIALE VOLANTINO	NR	2,000
007.3825	PERNO REGISTRO TENSIONAMENTO LAMA	NR	1,000
007.3843	ALBERO VOLANO LIBERO	NR	1,000
007.3884	LARDONE SLITTA TENDILAMA	NR	2,000
007.4002	STAFFA TESTINA GUIDALAMA ANTERIORE	NR	1,000
010.0352	GHIERA AUTOBLOCCANTE 35X1,5	NR	1,000
010.0915	MOLLA A TAZZA	NR	6,000
010.0928	MOLLA X IMPUGNATURA	NR	1,000
010.1712	GUIDALAMA 1 INSERTO ANTERIORE	NR	1,000
010.1714	GUIDALAMA 2 INSERTI ANTERIORE	NR	1,000
010.1721	PREMILAMA	NR	1,000
010.1909	LEVA COMANDO TESTA BT/NOT-AUS	NR	1,000
010.2381	TESTINA GUIDALAMA ANTERIORE	NR	1,000
010.7203	DADO M6	NR	6,000
010.7402	GRANO VCE P.CIL. 6 X 12	NR	5,000
010.7409	GRANO VCE P.CIL. 8 X 10	NR	1,000
010.7410	GRANO VCE P.CIL. 8 X 16	NR	1,000
010.7456	GRANO VCE P.CON. 8 X 16	NR	1,000
010.7461	GRANO VCE PUNTA PIANA 6 X 25	NR	6,000
010.7491	GRANO VCE PUNTA PIANA 10 X 60	NR	1,000
010.7603	RONDELLA DIAM. 6	NR	7,000
010.7606	RONDELLA DIAM. 12	NR	1,000
010.7700	SPINA CILINDRICA DIAM. 4 X 24	NR	1,000
010.7764	SPINA ELASTICA DIAM. 6 X 20	NR	4,000
010.7767	SPINA ELASTICA DIAM. 6 X 35	NR	1,000
010.7800	VITE AUTOFILETTANTE 2,9 X 15	NR	3,000
010.7868	VITE TCEI 6 X 12	NR	1,000
010.7890	VITE TCEI 8 X 12	NR	2,000
010.7893	VITE TCEI 8 X 20	NR	2,000
010.7894	VITE TCEI 8 X 25	NR	4,000
010.7942	VITE TCEI 12 X 40	NR	1,000
010.7943	VITE TCEI 12 X 45	NR	2,000
016.0261	PROTEZIONE LAMA ANTERIORE	NR	1,000
022.0515	MICROINTERRUTTORE V-21-1C6	NR	1,000
022.2151	TENSIONATORE ELETTRONICO	NR	1,000
025.0069	CUSCINETTO 32007X	NR	2,000
025.0272	ANELLO DI PROTEZIONE NILOS 32007	NR	2,000
025.0691	SERIE GUARNIZIONI X IMPUGNATURA MEP	NR	3,000
028.0130	RACCORDO 1/4-9 CL 2601	NR	1,000
028.0151	TUBO PLASTIFICATO 07-11	MT	1,000
034.0206	VOLANTINO TENSIONAMENTO LAMA	NR	1,000
034.1002	LEVA A SCATTO 10 MA	NR	1,000
034.1221	IMPUGNATURA DIS. MEP	NR	3,000
043.0229	RIDUZIONE MF 1/4 - CL 2520	NR	1,000
043.0652	RUBINETTO 1/4 F.M.	NR	1,000
090.0271	IMPUGNATURA COMPLETA TIPO MEP	NR	1,000

Doorsnede aandrijfswiel

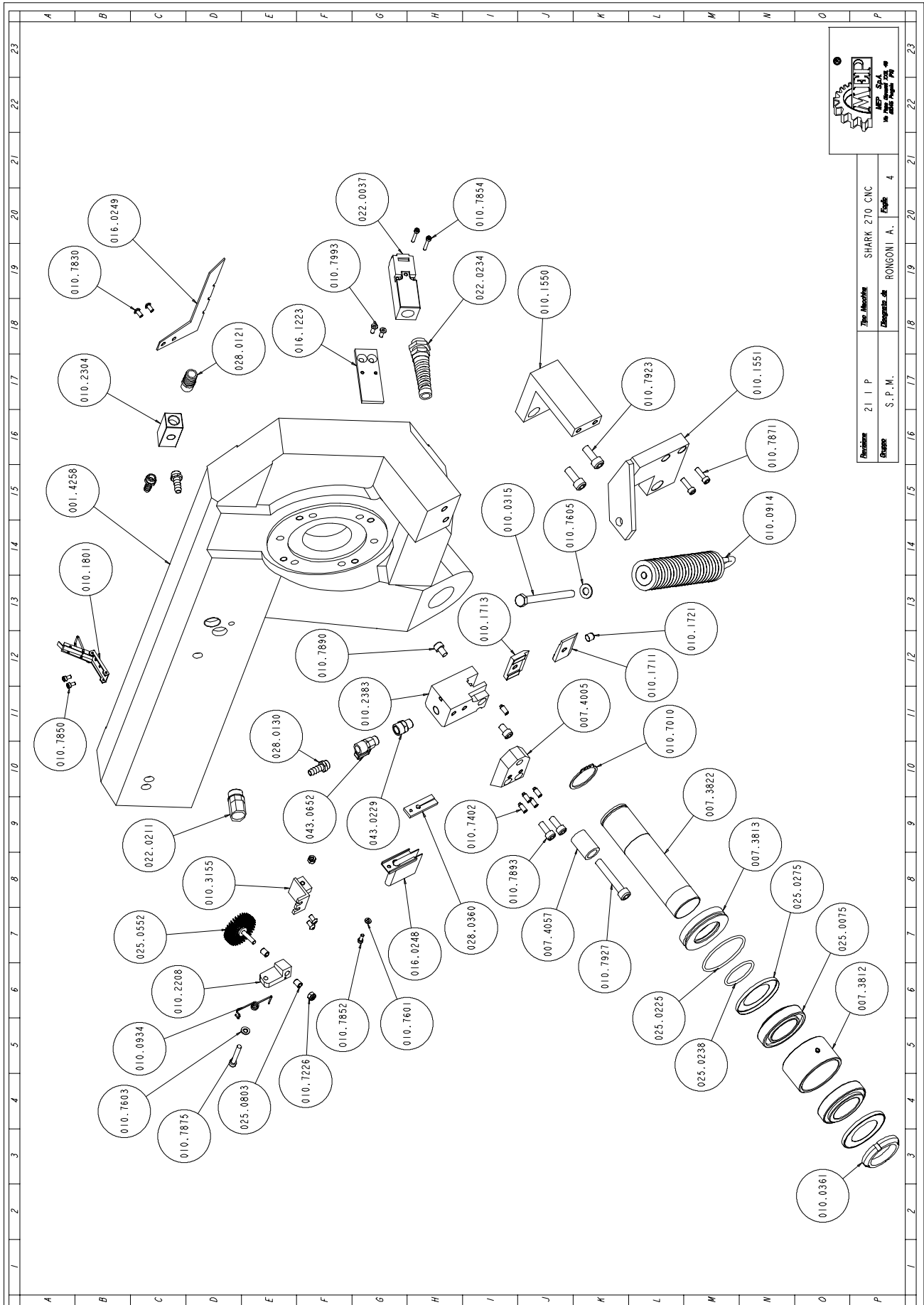

Revisie	21 P	The Machine	SHARK 270 CNC
Opmaak	S.P.M.	Dispersie.nl	RONGONI A.
			Bladz. 4



Art. NR.	Benaming	M.	Hoeveelheid
001.4258	ARCHETTO SEZIONE PULEGGIA MOTRICE	NR	1,000
007.3812	DISTANZIALE CUSCINETTO SNODO TESTA	NR	1,000
007.3813	DISTANZIALE ARCHETTO	NR	1,000
007.3822	PERNO SUPPORTO SNODO TESTA	NR	1,000
007.4005	STAFFA TESTINA GUIDALAMA POSTERIORE	NR	1,000
007.4057	BOCCOLA BATTUTA FINE CORSA	NR	1,000
010.0315	VITE 8.8 T.E. 10X120 BRUNITO	NR	1,000
010.0361	GHIERA DI PRECISIONE 45X1,5	NR	1,000
010.0914	MOLLA RICHIAMO TESTA	NR	1,000
010.0934	MOLLA X PULILAMA	NR	1,000
010.1550	STAFFA SUPPORTO CILINDRO SH 270 CNC	NR	1,000
010.1551	STAFFA ESTERNA CILINDRO SH 270 CNC	NR	1,000
010.1711	GUIDALAMA 1 INSERTO POSTERIORE	NR	1,000
010.1713	GUIDALAMA 2 INSERTI POSTERIORE	NR	1,000
010.1721	PREMILAMA	NR	1,000
010.1801	"CHIUSSURA LEVA "D" ZINCATA"	NR	1,000
010.2208	PORTASPAZZOLA PULILAMA	NR	1,000
010.2304	DISTRIBUTORE LIQUIDO REFRIGERANTE	NR	1,000
010.2383	TESTINA GUIDALAMA	NR	1,000
010.3155	.STAFFA FIX SPAZZOLA PULILAMA	NR	1,000
010.7010	ANELLO SEEGER DIAM. 45 US.010.1201	NR	1,000
010.7226	DADO AUTOBLOCCANTE M6	NR	2,000
010.7402	GRANO VCE P.CIL. 6 X 12	NR	5,000
010.7601	RONDELLA DIAM. 4	NR	1,000
010.7603	RONDELLA DIAM. 6	NR	1,000
010.7605	RONDELLA DIAM. 10	NR	1,000
010.7830	VITE BUTON 5 X 10	NR	4,000
010.7850	VITE TCEI 4 X 8	NR	2,000
010.7852	VITE TCEI 4 X 12	NR	1,000
010.7854	VITE TCEI 4 X 25	NR	2,000
010.7871	VITE TCEI 6 X 20	NR	2,000
010.7875	VITE TCEI 6 X 40	NR	1,000
010.7890	VITE TCEI 8 X 12	NR	2,000
010.7893	VITE TCEI 8 X 20	NR	2,000
010.7923	VITE TCEI 10 X 25	NR	2,000
010.7927	VITE TCEI 10 X 60	NR	1,000
010.7993	VITE TSPEI 5 X 12	NR	2,000
016.0248	PROTEZIONE NASTRO	NR	1,000
016.0249	PROTEZIONE LAMA POSTERIORE	NR	1,000
016.1223	PIASTR.FIX INTERR.SICUR.ARCHETTO	NR	1,000
022.0037	INTERRUTTORE DI SICUREZZA FR 690	NR	1,000
022.0211	RACCORDO RAPIDO SEM PG 13,5	NR	1,000
022.0234	PRESSACORDONE 3246 NERO PG 13,5	NR	1,000
025.0075	CUSCINETTO 32009X	NR	2,000
025.0225	ANELLO TENUTA OR 171-68,26	NR	1,000
025.0238	ANELLO DI TENUTA OR 44.45X3,53	NR	1,000
025.0275	ANELLO DI PROTEZIONE NILOS 32009X	NR	2,000
025.0552	SPAZZOLA PULILAMA 6X25 030 GG53	NR	1,000
025.0803	BOCCOLA GRAFITATA L. 10 DIAM. 6	NR	2,000
028.0121	RACCORDO 3/8-17 CL 2601	NR	1,000
028.0130	RACCORDO 1/4-9 CL 2601	NR	3,000
028.0360	GOMMINO PULILAMA	NR	1,000
043.0229	RIDUZIONE MF 1/4 - CL 2520	NR	1,000
043.0652	RUBINETTO 1/4 F.M.	NR	1,000

Afdekking zaagbeugel

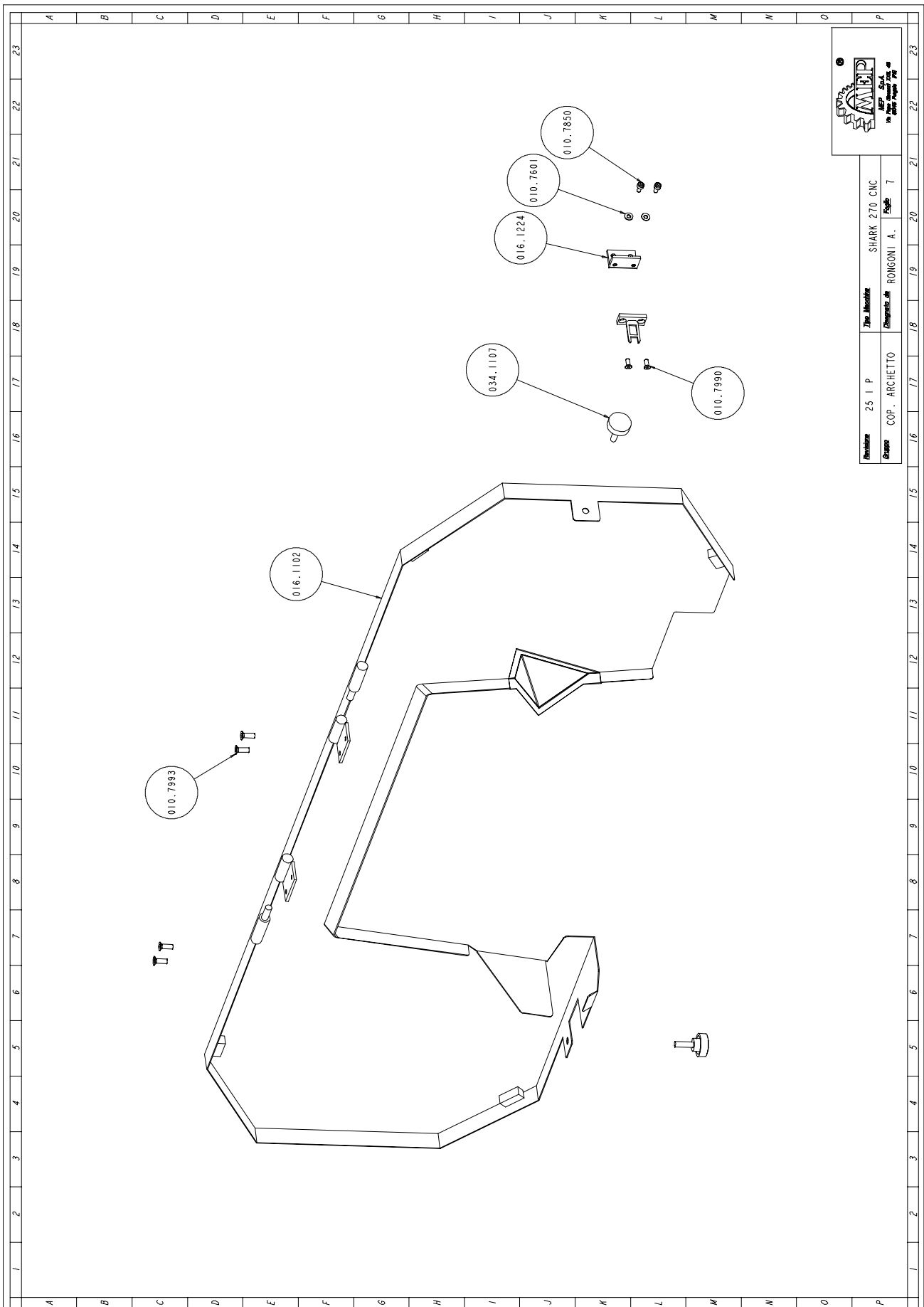

Art. NR.	Benaming	M.	Hoeveelheid
010.7601	RONDELLA DIAM. 4	NR	2,000
010.7850	VITE TCEI 4 X 8	NR	2,000
010.7990	VITE TSPEI 4 X 8	NR	2,000
010.7993	VITE TSPEI 5 X 12	NR	4,000
016.1102	COPERCHIO ARCHETTO	NR	1,000
016.1224	PIASTR.FIX INTER.SICUR.COPERCHIO	NR	1,000
034.1107	VOLANTINO DIAM.30 M6 X 20	NR	2,000

Klemgroep

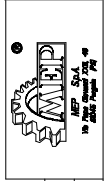
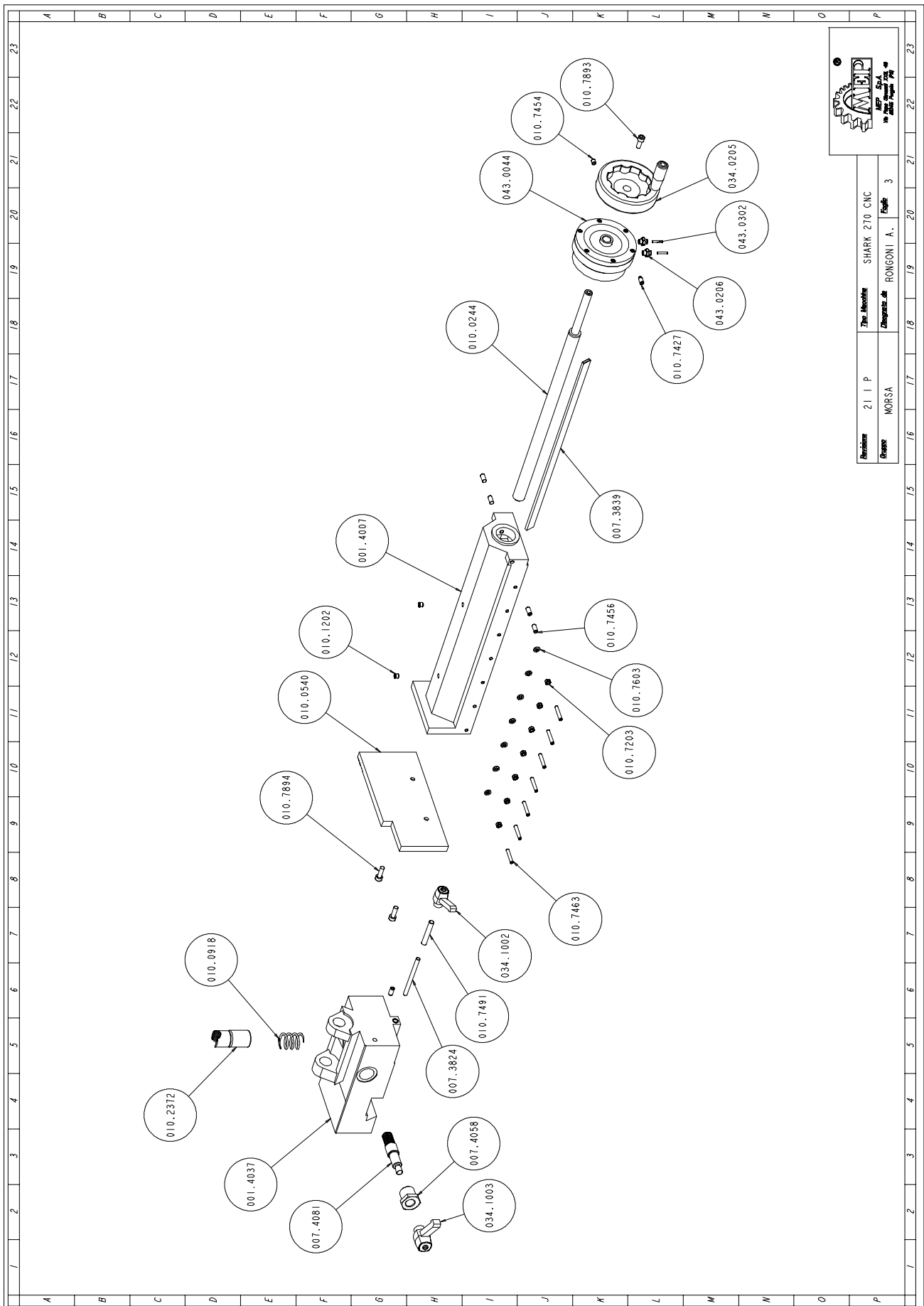

Revisione	2 1 P	The Machine	SHARK 270 CNC
Disegnata da	MORSA	Disegnata da	RONGONI A.
		Scala	3

Art. NR.	Benaming	M.	Hoeveelheid
001.4007	SCORREVOLE MORSA	NR	1,000
001.4037	SUPPORTO MORSA	NR	1,000
007.3824	PERNO BLOCCAGGIO MORSA MSR	NR	1,000
007.3839	LARDONE MORSA	NR	1,000
007.4058	BOCCOLA ECCENTRICA	NR	1,000
007.4081	PIGNONE SBLOCCAGGIO SCORREVOLE	NR	1,000
010.0244	VITE MORSA	NR	1,000
010.0540	GANASCIA MORSA MOBILE SH 270	NR	1,000
010.0918	MOLLA RICHIAMO CHIOCC.VITE MORSA	NR	1,000
010.1202	OLIATORE A SFERA DIAM. 8	NR	2,000
010.2372	CHIOCCIOLA BRONZO 45Ø	NR	1,000
010.7203	DADO M6	NR	7,000
010.7427	GRANO VCE P.CIL. 8 X 12	NR	1,000
010.7454	GRANO VCE P.CON. 8 X 8	NR	1,000
010.7456	GRANO VCE P.CON. 8 X 16	NR	5,000
010.7463	GRANO VCE P.CON. 6 X 35	NR	7,000
010.7491	GRANO VCE PUNTA PIANA 10 X 60	NR	1,000
010.7603	RONDELLA DIAM. 6	NR	7,000
010.7859	VITE TCEI 5 X 12	NR	4,000
010.7860	VITE TCEI 5 X 15	NR	6,000
010.7893	VITE TCEI 8 X 20	NR	1,000
010.7894	VITE TCEI 8 X 25	NR	2,000
025.0203	ANELLO TENUTA 35X25X7	NR	1,000
025.0452	RULLI 6X6 AISI 420	NR	1,000
034.0205	VOLANTINO VPRA/125 MR	NR	1,000
034.1002	LEVA A SCATTO 10 MA	NR	1,000
034.1003	LEVA A SCATTO 12 MA	NR	1,000
043.0044	CILINDRO VOLAMP.100-8 CIRCOL.	NR	1,000
043.0206	ATTACCO A ESAGONO 4X1/8 - CL 6511	NR	2,000
043.0302	TUBO RILSAN 4X2.7 BIANCO C.17257162	MT	2,000
090.5201	PARTICOLARI	NR	3,000

Groep onderstel

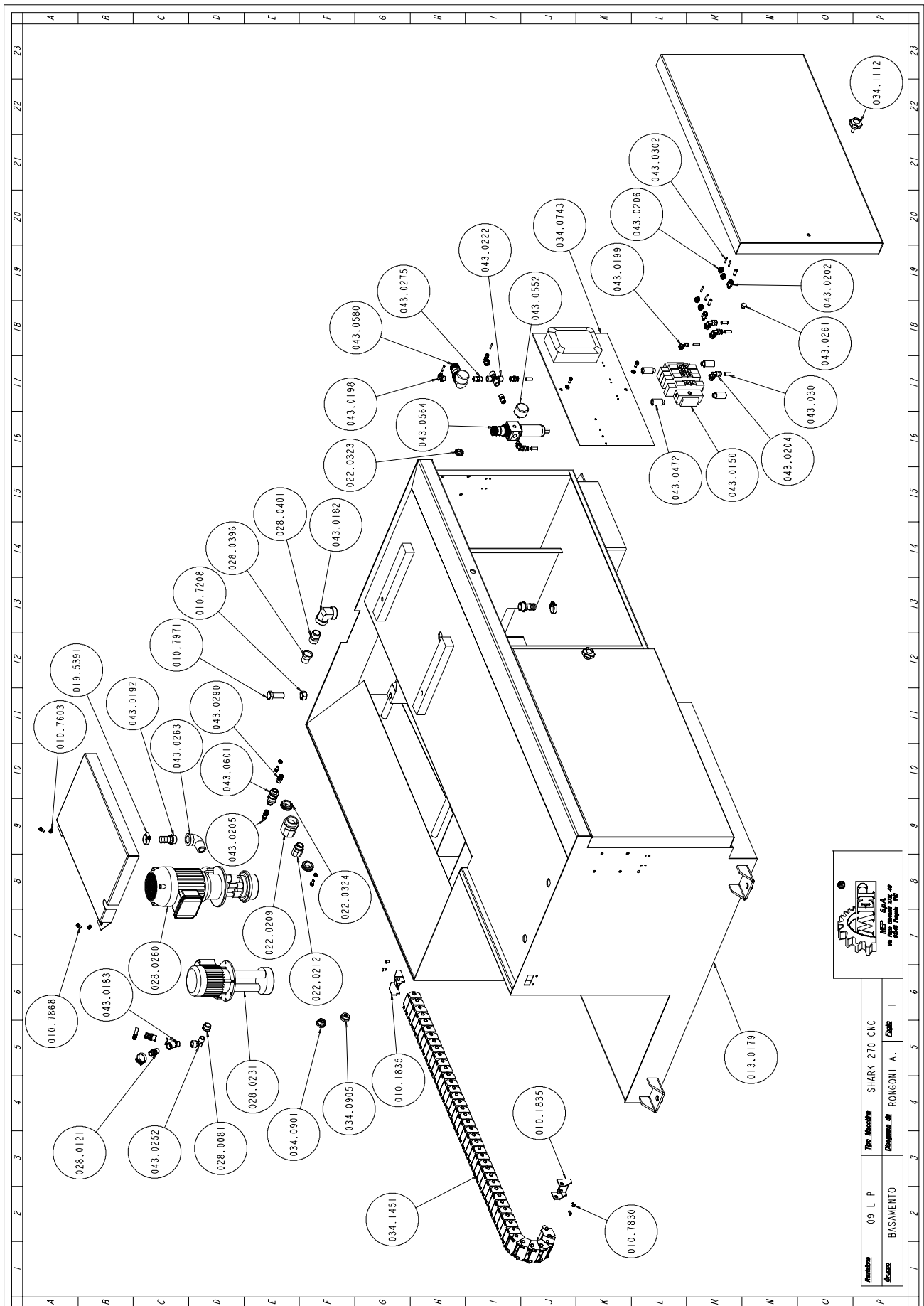

Revisione	09 L P	Titolo	Macchine SHARK 270 CNC
Gruppo	BASAMENTO	Disegnato da	RONGONI A.
		Foglio	I

Art. NR.	Benaming	M.	Hoeveelheid
010.1835	SET ATTACCHI 117.4.12.P AX-CNC	NR	2,000
010.7208	DADO M16	NR	1,000
010.7221	DADO M16 BASSO	NR	1,000
010.7480	GRANO VCE PUNTA PIANA 8 X 30	NR	2,000
010.7603	RONDELLA DIAM. 6	NR	8,000
010.7830	VITE BUTON 5 X 10	NR	4,000
010.7868	VITE TCEI 6 X 12	NR	8,000
010.7971	VITE TE 16 X 40	NR	1,000
013.0179	PIEDISTALLO SH 270 CNCFE	NR	1,000
016.1197	PANNELLO CABL.APP.PN.SH 320 AX 60Ø	NR	1,000
019.5391	FASCETTA MINUS GT	NR	4,000
022.0209	RACCORDO RAPIDO SEM 29 ART.3800296	NR	1,000
022.0212	RACCORDO RAPIDO SEM PG 16	NR	1,000
022.0232	PRESSACAVO IN OTTONE 1/4 BM 2450	NR	7,000
022.0242	DADO IN OTTONE BM 2460 1/4	NR	7,000
022.0323	PASSACAVI 18 INC.MM.2,5	NR	1,000
022.0324	PASSACAVI 24 INC.MM.2,5	NR	2,000
028.0081	RIDUZIONE FM 1/2-3/8 - CL 2531	NR	1,000
028.0121	RACCORDO 3/8-17 CL 2601	NR	2,000
028.0231	ELET.60/150 220-230-240/380-415.50	NR	1,000
028.0260	ELETTR.LPA25/120 KW0,37 V.230/400.5	NR	1,000
028.0396	UGELLO 0 20 SPD FP50.11B50	NR	1,000
028.0401	RACCORDO 3/4 SPD FP50.17A20	NR	1,000
034.0901	"TAPPO LIVELLO OLIO 1/2 ""GAS."	NR	1,000
034.0905	"TAPPO OLIO TAO/3 1/2"" NERO"	NR	1,000
034.1112	VOLANTINO DIAM.40 M8	NR	2,000
034.1451	CATENA PORTACAVI E17.04.63.0	MT	1,000
043.0150	BLOCCO DI VALVOLE DA 4 SH 270 CNCFE	NR	1,000
043.0182	RACCORDO A GOMITO FF ZINCATO 3/4	NR	1,000
043.0183	RACCORDO A Y 90Ø MASCHIO 3/8	NR	1,000
043.0192	RACCORDO RB 9889 3/4X20	NR	2,000
043.0198	ATTACCO A GOMITO GIREV.4X1/4 CL6521	NR	1,000
043.0202	ATTACCO A ESAGONO 8X1/8 - CL 6511	NR	2,000
043.0204	ATTACCO A GOMITO 8X1/4 - CL 6521	NR	5,000
043.0205	ATTACCO A ESAGONO 8X1/4 - CL 6510	NR	1,000
043.0206	ATTACCO A ESAGONO 4X1/8 - CL 6511	NR	4,000
043.0222	RACCORDO A CROCE CL 2033 1/4	NR	1,000
043.0229	RIDUZIONE MF 1/4 - CL 2520	NR	1,000
043.0250	GOMITO M.F. 1/4 CL 2020	NR	1,000
043.0252	GOMITO MF 3/8 CL 2020	NR	1,000
043.0261	TAPPO TTE8 1/8 - CL 2611	NR	1,000
043.0263	RACCORDO A GOMITO M/F ZINCATO 3/4	NR	1,000
043.0275	NIPPLO CONICO A2-1/4 - CL 2500	NR	2,000
043.0290	INNESTO RAPIDO 1/4 GHIOTTO 13/A	NR	2,000
043.0302	TUBO RILSAN 4X2.7 BIANCO C.17257162	MT	5,000
043.0472	SILENZIATORE 1/4- PLASTICA	NR	4,000
043.0552	MANOMETRO DIAM. 40	NR	2,000
043.0564	FR 1/4 20-08	NR	1,000
043.0580	REGOLATORE MR 1/4 O-8	NR	1,000
043.0601	VALVOLA VMS 114-1/4 08	NR	1,000

Bedieningspaneel

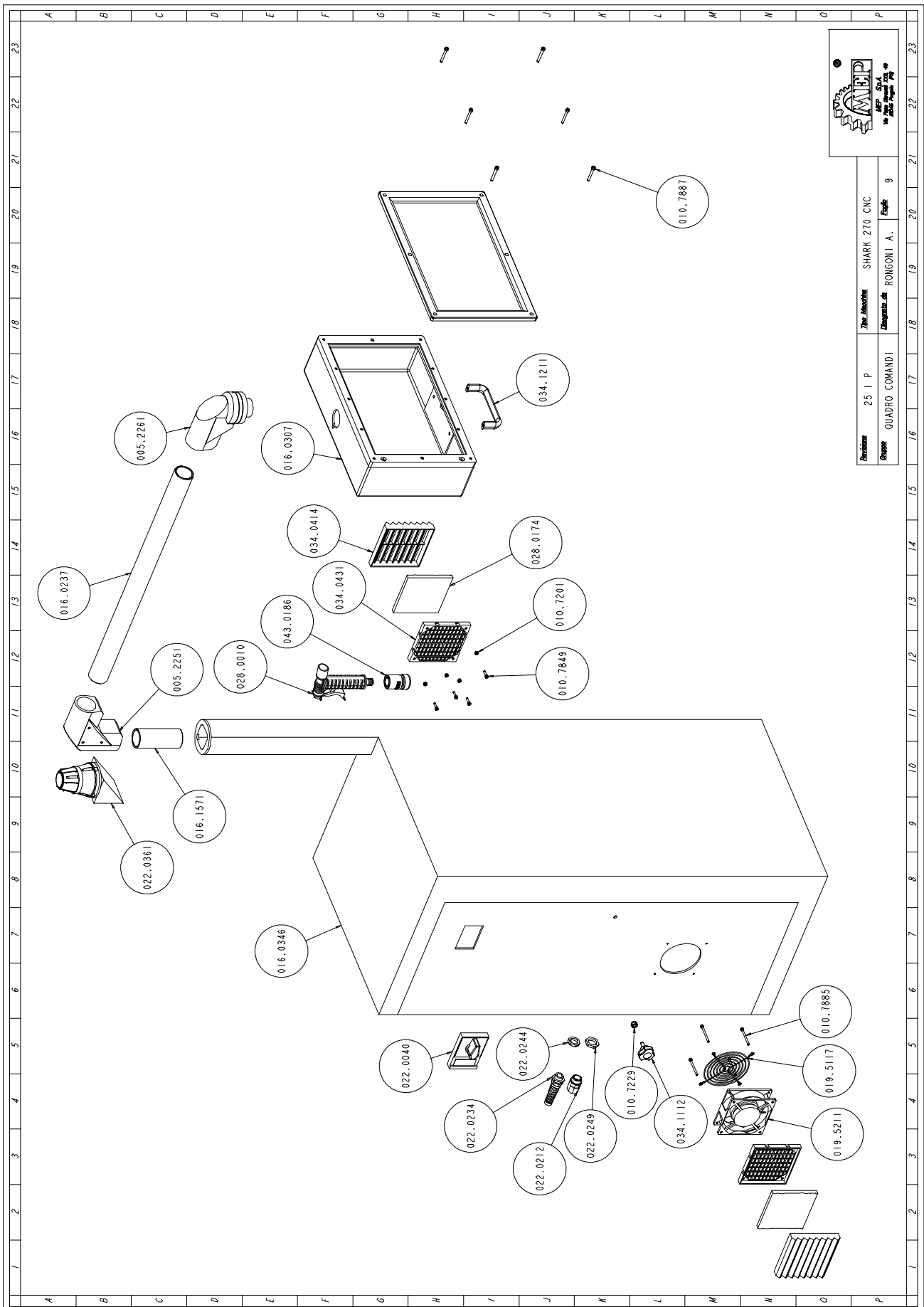

Art. NR.	Benaming	M.	Hoeveelheid
005.2251	ANGOLO X QUADRO COMANDI	NR	1,000
005.2261	GIUNTO ANGOLO X QUADRO 497500	NR	1,000
010.7201	DADO M4	NR	4,000
010.7229	DADO AUTOBLOCCANTE M8	NR	1,000
010.7481	GRANO VCE PUNTA PIANA 8 X 35	NR	1,000
010.7849	VITE TCEI 4 X 16	NR	4,000
010.7868	VITE TCEI 6 X 12	NR	2,000
010.7885	VITE TCEI 4 X 50	NR	4,000
010.7887	VITE TCEI 5 X 40	NR	6,000
016.0242	ASTA MOBILE X CONSOLLE	NR	1,000
016.0307	QUADRO COMANDI MEP-E	NR	1,000
016.0346	QUADRO ELETTRICO	NR	1,000
016.1571	MANICOTTO X ANGOLO COMMANDER	NR	1,000
019.5117	COPRIVENTOLA	NR	1,000
019.5211	VENTOLA 4715MS 23TB	NR	1,000
022.0040	COMANDO BLOCCOPORTA 3ZV19260B	NR	1,000
022.0212	RACCORDO RAPIDO SEM PG 16	NR	1,000
022.0234	PRESSACORDONE 3246 NERO PG 13,5	NR	1,000
022.0244	CONTRODADO 3217B GRIGIO PG 13	NR	1,000
022.0249	DADO POLIAM.HUMMEL 1.262.1600.11	NR	1,000
022.0361	LAMPADA MICROLUX C.24 V. CON SUONO	NR	1,000
028.0010	PISTOLA	NR	1,000
028.0174	FILTRO M12R X VENTOLA	NR	2,000
034.0414	COPERCHIO ALETT. A12C-7032	NR	2,000
034.0431	BASE A12B - 7032	NR	2,000
034.1112	VOLANTINO DIAM.40 M8	NR	1,000
034.1211	MANIGLIA GN-565-20-128.SW	NR	1,000
043.0186	RACCORDO FEMMINA 1/2 AQUASTOP	NR	1,000

Handvat

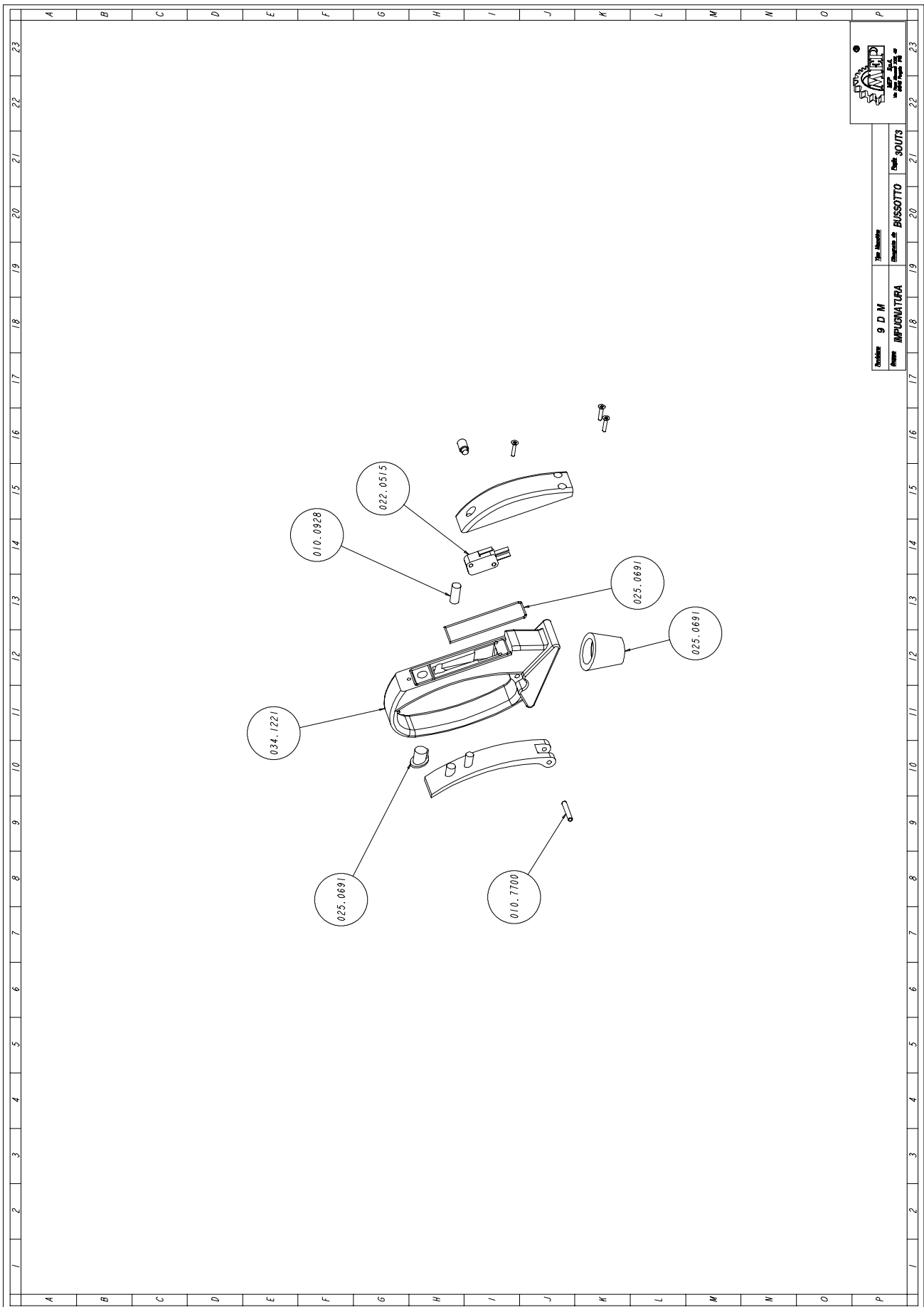

Art. NR.	Benaming	M.	Hoeveelheid
010.0928	MOLLA X IMPUGNATURA	NR	1,000
010.7409	GRANO VCE P.CIL. 8 X 10	NR	1,000
010.7700	SPINA CILINDRICA DIAM. 4 X 24	NR	1,000
010.7800	VITE AUTOFILETTANTE 2,9 X 15	NR	3,000
022.0515	MICROINTERRUTTORE V-21-1C6	NR	1,000
025.0691	SERIE GUARNIZIONI X IMPUGNATURA MEP	NR	1,000
034.1221	IMPUGNATURA DIS. MEP	NR	1,000

Veiligheidsstang-voor groep

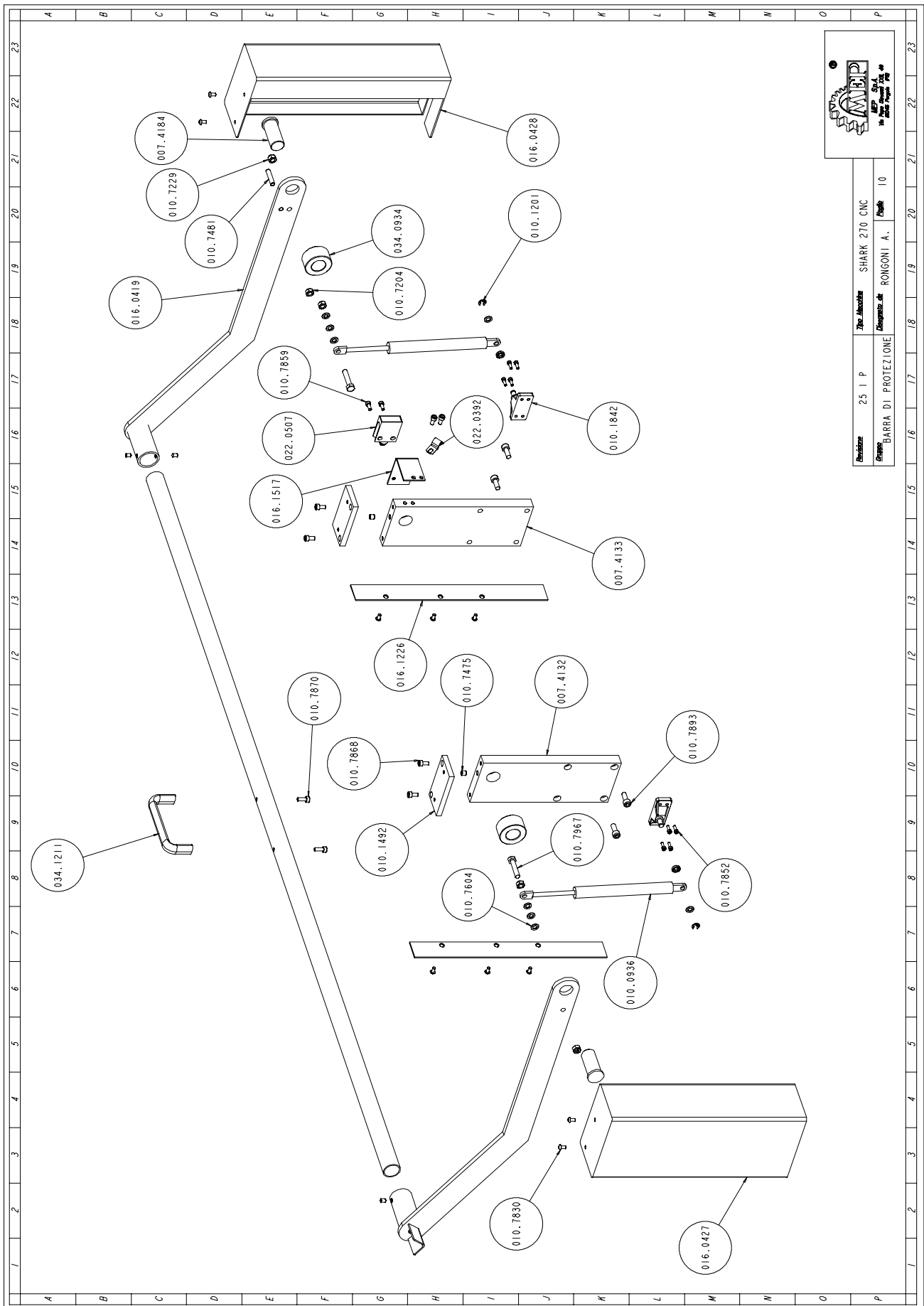

		Revisione	25 P	Disegnata	SHARK 270 CNC
		Disegnata	BARRA DI PROTEZIONE	Disegnata da	ROMGONI A.
		Scala	10		

Art. NR.	Benaming	M.	Hoeveelheid
007.4132	SUPPORTO DX BARRA PROTEZIONE	NR	1,000
007.4133	SUPPORTO SX BARRA PROTEZIONE	NR	1,000
007.4184	PERNO BARRA PROTEZIONE	NR	2,000
010.0936	MOLLA GAS	NR	2,000
010.1201	VITERIA E BULLONERIA	NR	2,000
010.1492	STAFFA FIX BARRA PROTEZIONE	NR	2,000
010.1842	SUPPORTO MASCHIO X MOLLA A GAS	NR	2,000
010.2508	BARRA DI PROTEZIONE ANTERIORE SH	NR	1,000
010.7204	DADO M8	NR	3,000
010.7229	DADO AUTOBLOCCANTE M8	NR	2,000
010.7450	GRANO VCE P.CIL. 6 X 6	NR	4,000
010.7475	GRANO VCE P.PIANA 8 X 8	NR	2,000
010.7481	GRANO VCE PUNTA PIANA 8 X 35	NR	1,000
010.7604	RONDELLA DIAM. 8	NR	8,000
010.7830	VITE BUTON 5 X 10	NR	1,000
010.7852	VITE TCEI 4 X 12	NR	8,000
010.7859	VITE TCEI 5 X 12	NR	2,000
010.7868	VITE TCEI 6 X 12	NR	6,000
010.7870	VITE TCEI 6 X 16	NR	2,000
010.7893	VITE TCEI 8 X 20	NR	4,000
010.7967	VITE TE 8 X 40	NR	2,000
016.0427	PROTEZIONE DX BARRA ALIMENTORE	NR	1,000
016.0428	PROTEZIONE SX BARRA ALIMENTORE	NR	1,000
016.0606	SUPPORTO BARRA DI PROTEZIONE SX	NR	1,000
016.0607	SUPPORTO BARRA DI PROTEZIONE DX	NR	1,000
016.1226	PIASTRINO CHIUSURA PROTEZ.DX-SX	NR	2,000
016.1517	STAFFA FIX F.C.BARRA PROTEZIONE	NR	1,000
022.0392	GRAFFETTE IN ACCIAIO DM 10-11	NR	1,000
022.0507	FINECORSO D4C-1G02 1M	NR	1,000
034.0934	TAPPO DISTANZ.BARRA PROTEZIONE	NR	2,000
034.1211	MANIGLIA GN-565-20-128.SW	NR	1,000

Groep vaste tafel

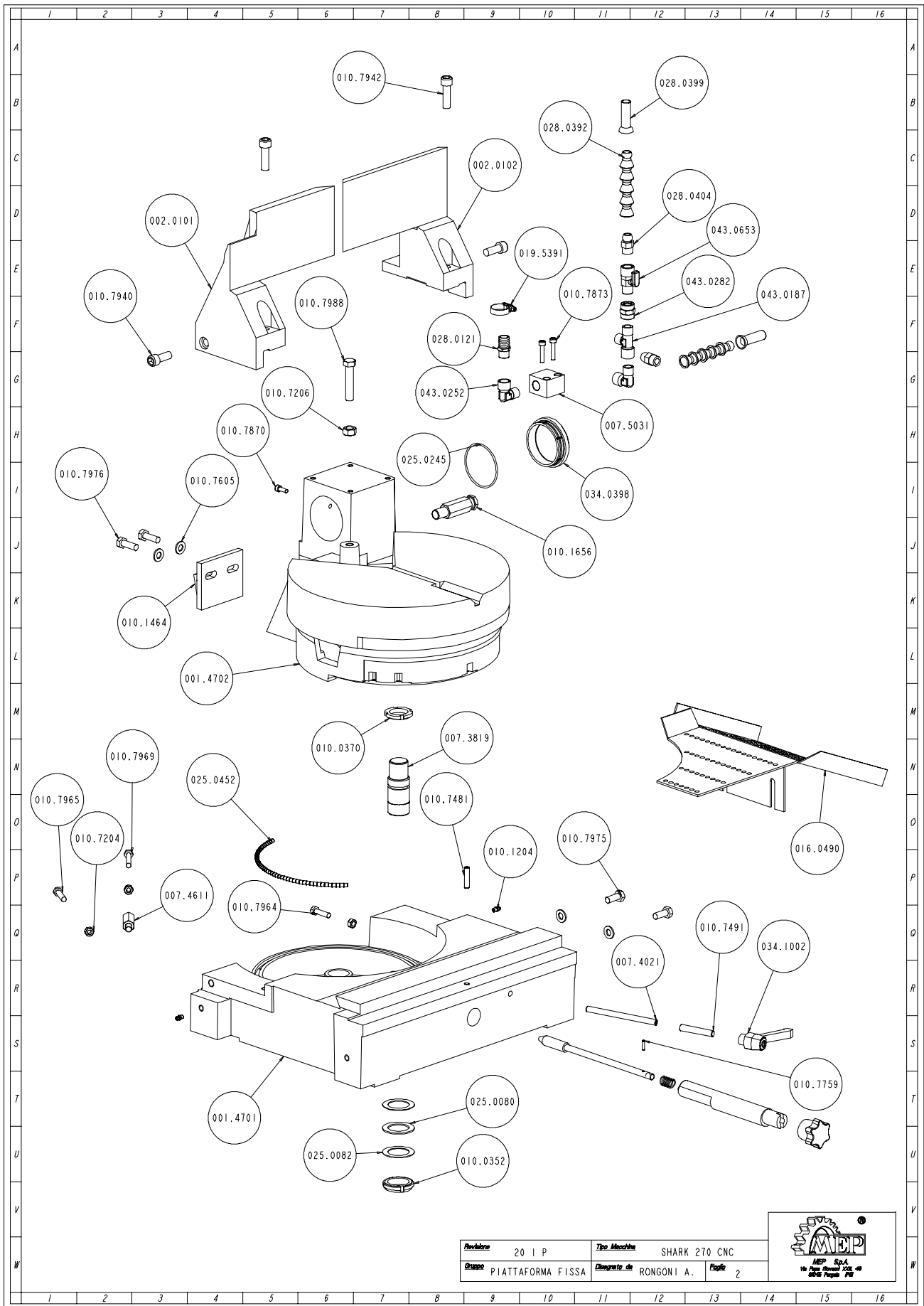

Revisione	20 I P	Tipi Macchine	SHARK 270 CNC
Gruppo	PIATTAFORMA FISSA	Disegnato da	RONGONI A.
		Esigite	2



Art. NR.	Benaming	M.	Hoeveelheid
001.4701	PIATTAFORMA FISSA SH 270	NR	1,000
001.4702	PIANO ROTANTE SH 270	NR	1,000
002.0101	SQUADRO MORSA SINISTRO	NR	1,000
002.0102	SQUADRO MORSA DESTRO	NR	1,000
007.3819	PERNO DI CENTRO	NR	1,000
007.4021	PERNO BLOCCAGGIO PIANO GIREVOLE	NR	1,000
007.4536	PERNO PUNTO FISSO	NR	1,000
007.4601	CILINDRETTO PUNTO FISSO	NR	1,000
007.4611	BATTUTA X 60Ø DX-SX	NR	1,000
007.5031	SQUADRETTO X LIQUIDO PIANO GIREVOLE	NR	1,000
010.0352	GHIERA AUTOBLOCCANTE 35X1,5	NR	1,000
010.0370	GHIERA 5S 30X1,5	NR	1,000
010.0902	MOLLE PUNTO FISSO TESTA	NR	1,000
010.1204	INGRASSATORE M 6	NR	2,000
010.1464	STAFFA AGGANCIO MOLLA	NR	1,000
010.1656	PERNO AGGANCIO MOLLA	NR	1,000
010.3148	SUPPORTO BATTUTE SH 270	NR	1,000
010.7204	DADO M8	NR	3,000
010.7206	DADO M12	NR	1,000
010.7481	GRANO VCE PUNTA PIANA 8 X 35	NR	1,000
010.7491	GRANO VCE PUNTA PIANA 10 X 60	NR	1,000
010.7605	RONDELLA DIAM. 10	NR	4,000
010.7759	SPINA ELASTICA DIAM. 3 X 16	NR	1,000
010.7870	VITE TCEI 6 X 16	NR	1,000
010.7873	VITE TCEI 6 X 30	NR	2,000
010.7876	VITE TCEI 6 X 45	NR	2,000
010.7940	VITE TCEI 12 X 30	NR	2,000
010.7942	VITE TCEI 12 X 40	NR	2,000
010.7964	VITE TE 8 X 30	NR	1,000
010.7965	VITE TE 8 X 35	NR	1,000
010.7969	VITE TE 8 X 50	NR	1,000
010.7975	VITE TE 10 X 25	NR	2,000
010.7976	VITE TE 10 X 30	NR	2,000
010.7988	VITE TE 12 X 60	NR	1,000
016.0490	GUIDA SCARICA PEZZI SH 270 CNCFE	NR	1,000
019.5391	FASCETTA MINUS GT	NR	1,000
025.0080	GABBIA ASSIALE A RULLINI AXK 3552	NR	1,000
025.0082	RALLA AS 3552	NR	2,000
025.0239	ANELLO DI TENUTA OR 4112	NR	1,000
025.0452	RULLI 6X6 AISI 420	NR	5,000
028.0121	RACCORDO 3/8-17 CL 2601	NR	1,000
028.0392	TUBO LOOC LINE BZ44BO.0350 3/8	MT	2,000
028.0399	UGELLO 0 12,7 - 1/2 ART. 59863	NR	2,000
028.0402	RACCORDO 3/8 BZ 4480.0305	NR	2,000
028.0404	RACCORDO 3/8 NPT LOOC LINE 1/2	NR	1,000
034.0398	COPERCHIO SNODO TESTA SH N.T.	NR	1,000
034.1002	LEVA A SCATTO 10 MA	NR	1,000
034.1203	IMPUGNATURA NS. DISEGNO M10	NR	1,000
043.0187	ATTACCO A T FMM 3/8 CL 2050	NR	1,000
043.0252	GOMITO MF 3/8 CL 2020	NR	2,000
043.0282	MANICOTTO 3/8	NR	1,000
043.0653	RUBINETTO M/F 3/8 CL 6310	NR	1,000

Pneumatische groep

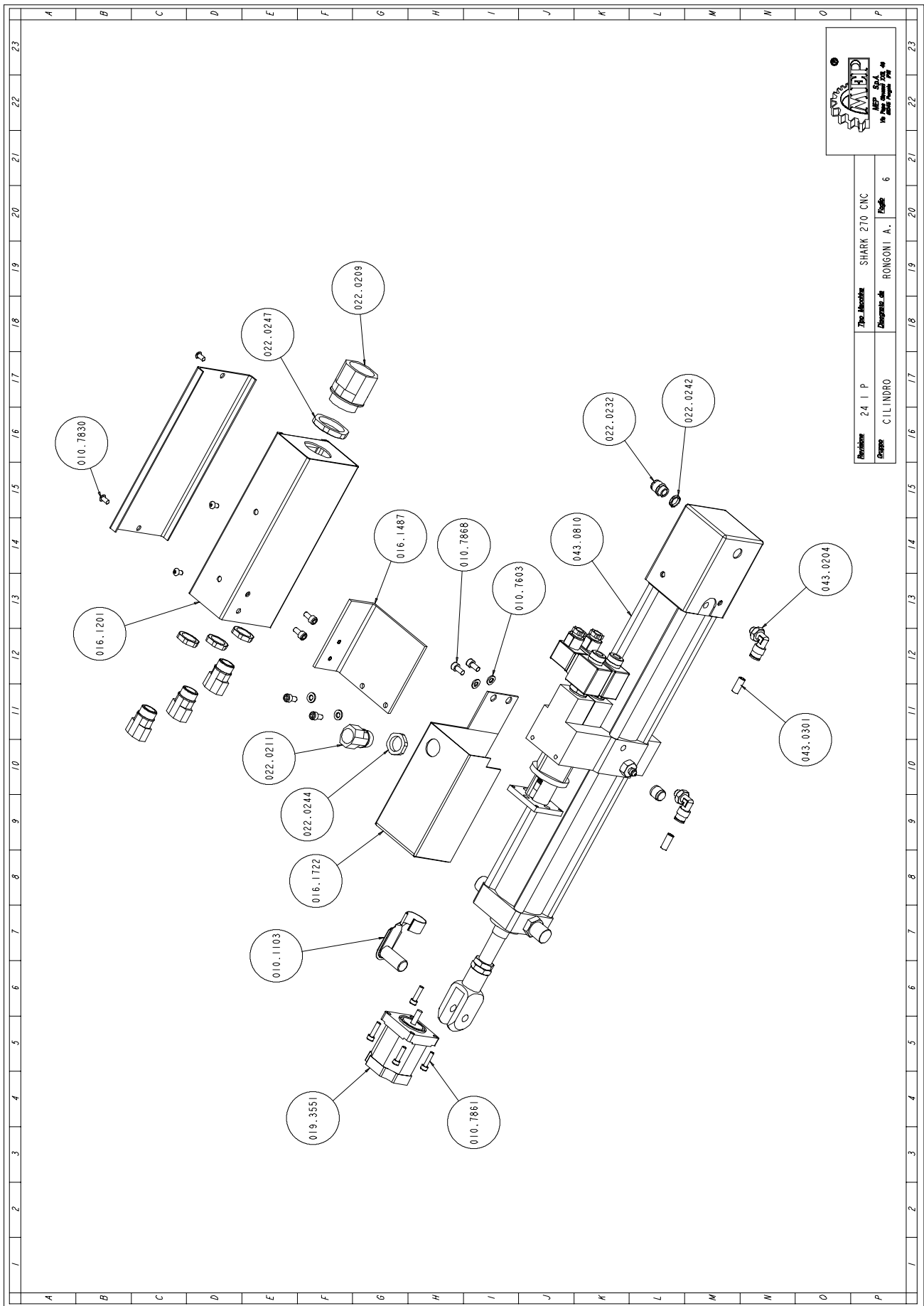

Art. NR.	Benaming	M.	Hoeveelheid
010.1103	FORCELLA 16 X 1,5	NR	2,000
010.7603	RONDELLA DIAM. 6	NR	4,000
010.7830	VITE BUTON 5 X 10	NR	4,000
010.7861	VITE TCEI 5 X 20	NR	4,000
010.7868	VITE TCEI 6 X 12	NR	6,000
016.1201	SCATOLA DI DERIVAZIONE	NR	1,000
016.1487	STAFFA FISSAGGIO SCATOLA DI DERIVA-	NR	1,000
016.1722	PROTEZIONE CILINDRO	NR	1,000
019.3551	MOTORE MAE MOD.HY 200 2232 190B8CNC	NR	1,000
022.0046	POTENZIOMETRO 6639S-001-202	NR	1,000
022.0209	RACCORDO RAPIDO SEM 29 ART.3800296	NR	1,000
022.0211	RACCORDO RAPIDO SEM PG 13,5	NR	4,000
022.0232	PRESSACAVO IN OTTONE 1/4 BM 2450	NR	1,000
022.0242	DADO IN OTTONE BM 2460 1/4	NR	1,000
022.0244	CONTRODADO 3217B GRIGIO PG 13	NR	4,000
022.0247	DADO POLIAM.HUMMEL 1.262.2900.11	NR	1,000
022.0378	CONNETT.BOBINA VALV. RIGENERATRICE	NR	2,000
022.0615	BOBINA X VALVOLA RIGENERATRICE CIL.	NR	2,000
025.0252	ANELLO DK 40X8X20/4 PDF	NR	1,000
025.0876	GIUNTO WA 6-6 MM.28 X CILINDRO	NR	2,000
043.0204	ATTACCO A GOMITO 8X1/4 - CL 6521	NR	2,000
043.0810	UNITA' OLEOPNEUMATICA 0 63 C.150	NR	1,000
043.5671	PROTEZIONE POTENZIOMETRO CILINDRO	NR	1,000
043.5681	SUPPORTO POTENZIOMETRO CILINDRO	NR	1,000
044.1251	VALVOLA RIGENERATRICE CILINDRO	NR	2,000
044.1257	VALVOLA DI CARICO CILINDRO	NR	1,000

Invoerwagen groep

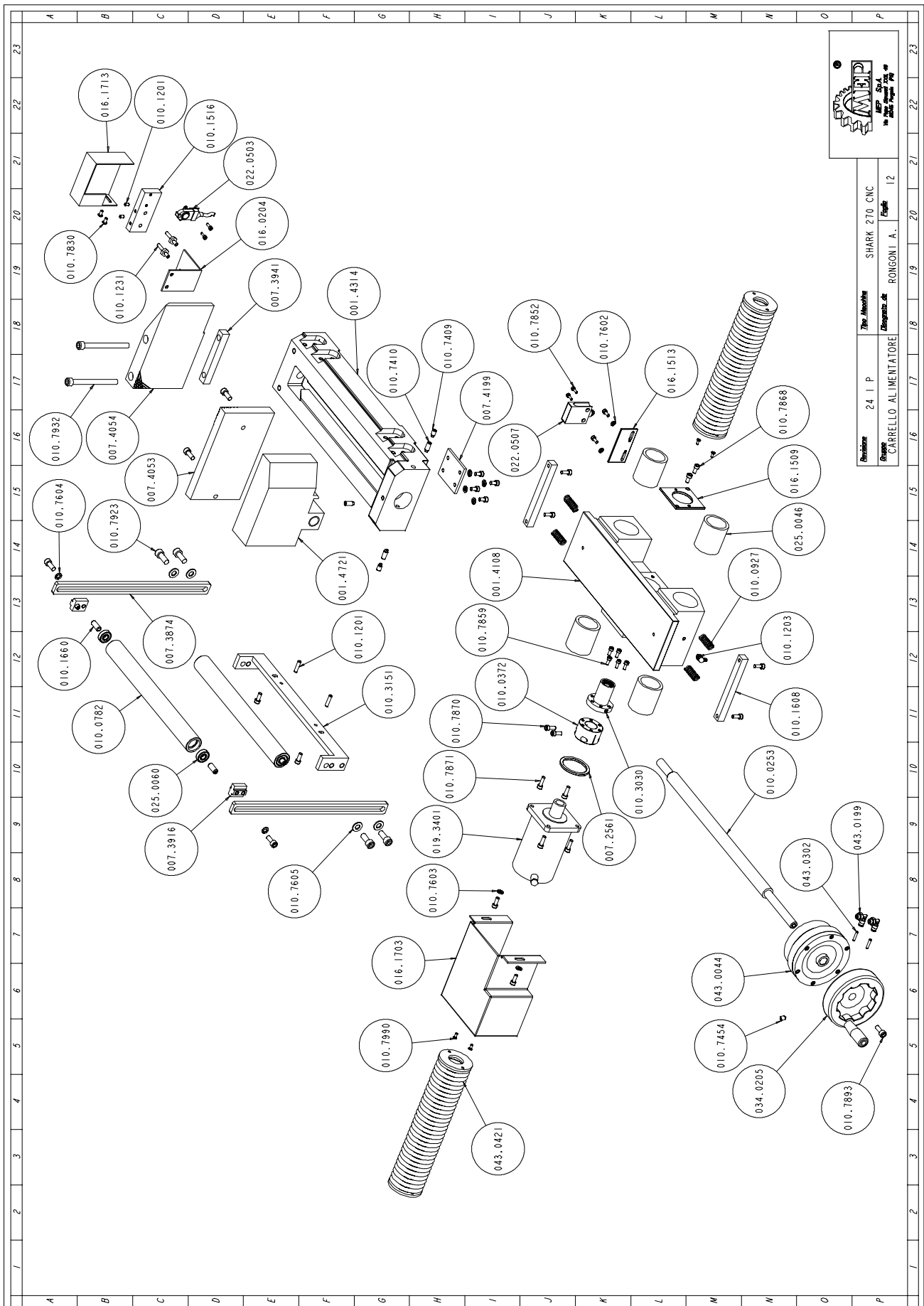

Art. NR.	Benaming	M.	Hoeveelheid
001.4108	CARRELLO ALIMENTATORE	NR	1,000
001.4314	MORSA ALIMENTATORE 60Ø	NR	1,000
001.4721	CHIOCCIOLA MORSA ALIMENTATORE	NR	1,000
007.2561	GHIERA CENTRAGGIO MOTORE CNCFE	NR	1,000
007.3874	SUPPORTO RULLO PREMIBARRA	NR	2,000
007.3916	TASSELLO FIX RULLO SUPPLEMENTARE	NR	2,000
007.3941	CHIAVETTA X GAN.FISSA ALIMENTATORE	NR	1,000
007.4053	CHIOCCIOLA VITE MORSA SH 270	NR	1,000
007.4054	GANASCIA FISSA ALIMENTATORE	NR	1,000
007.4199	PIASTR.FIX SCORR.MORSA ALIMENTATORE	NR	1,000
010.0253	VITE MORSA ALIM.567X24 SH FIL.SIN.	NR	1,000
010.0372	GHIERA FIX CHIOCCIOLA MOTORE	NR	1,000
010.0782	RULLO ALIMENTATORE	NR	1,000
010.0927	MOLLA CARRELLO ALIMENTATORE	NR	4,000
010.1201	VITERIA E BULLONERIA	NR	4,000
010.1203	OLIATORE A 90Ø 6X1	NR	1,000
010.1231	VITE FIX STAFFA F.C. ALIMENT. SH	NR	2,000
010.1516	STAFFA FIX F.C.ALIMENT.SH	NR	1,000
010.1608	TASSELLO MORSA BASCULANTE ALIMENTAT	NR	2,000
010.1660	PERNO SUPPORTO RULLO	NR	4,000
010.3030	CHIOCCIOLA RNFT1610-2,5 ALIMENTATOR	NR	1,000
010.3151	SUPPORTO RULLO MORSA ALIMENTATORE	NR	1,000
010.7409	GRANO VCE P.CIL. 8 X 10	NR	2,000
010.7410	GRANO VCE P.CIL. 8 X 16	NR	3,000
010.7454	GRANO VCE P.CON. 8 X 8	NR	1,000
010.7602	RONDELLA DIAM. 5	NR	2,000
010.7603	RONDELLA DIAM. 6	NR	6,000
010.7604	RONDELLA DIAM. 8	NR	2,000
010.7605	RONDELLA DIAM. 10	NR	4,000
010.7830	VITE BUTON 5 X 10	NR	2,000
010.7852	VITE TCEI 4 X 12	NR	4,000
010.7859	VITE TCEI 5 X 12	NR	11,000
010.7860	VITE TCEI 5 X 15	NR	6,000
010.7868	VITE TCEI 6 X 12	NR	6,000
010.7870	VITE TCEI 6 X 16	NR	1,000
010.7871	VITE TCEI 6 X 20	NR	4,000
010.7893	VITE TCEI 8 X 20	NR	5,000
010.7923	VITE TCEI 10 X 25	NR	4,000
010.7932	VITE TCEI 10 X 110	NR	2,000
010.7990	VITE TSPEI 4 X 8	NR	4,000
016.0204	SUPPORTO CATENA ALIMENTATORE	NR	1,000
016.1509	STAFFA FIX SOFFIETTO CIRCOLARE	NR	1,000
016.1513	STAFFA FIX MICROINTERRUTTORE	NR	1,000
016.1703	PROTEZIONE MOTORE ALIMENTATORE	NR	1,000
016.1713	PROTEZIONE F.CORSA ALIMENTATORE SH	NR	1,000
019.3401	MOTORE P/P KS200-085,3-R00,20 ALIM.	NR	1,000
022.0503	FINECORSO CROUZET 83.123.018	NR	1,000
022.0507	FINECORSO D4C-1G02 1M	NR	1,000
025.0046	MANICOTTO A SFERA 0658.040.00 AL.	NR	4,000
025.0060	CUSCINETTO 6000 2Z	NR	2,000
025.0203	ANELLO TENUTA 35X25X7	NR	1,000
025.0452	RULLI 6X6 AISI 420	NR	1,000
034.0205	VOLANTINO VPRA/125 MR	NR	1,000
043.0044	CILINDRO VOLAMP.100-8 CIRCOL.	NR	1,000
043.0199	ATTACCO A GOMITO GIREV.4X1/8 CL6521	NR	2,000
043.0302	TUBO RILSAN 4X2.7 BIANCO C.17257162	MT	2,000
043.0421	SOFFIETTO CIRCOLARE X ALIMENTATORE	NR	2,000

Aanvoerrollenbaan groep

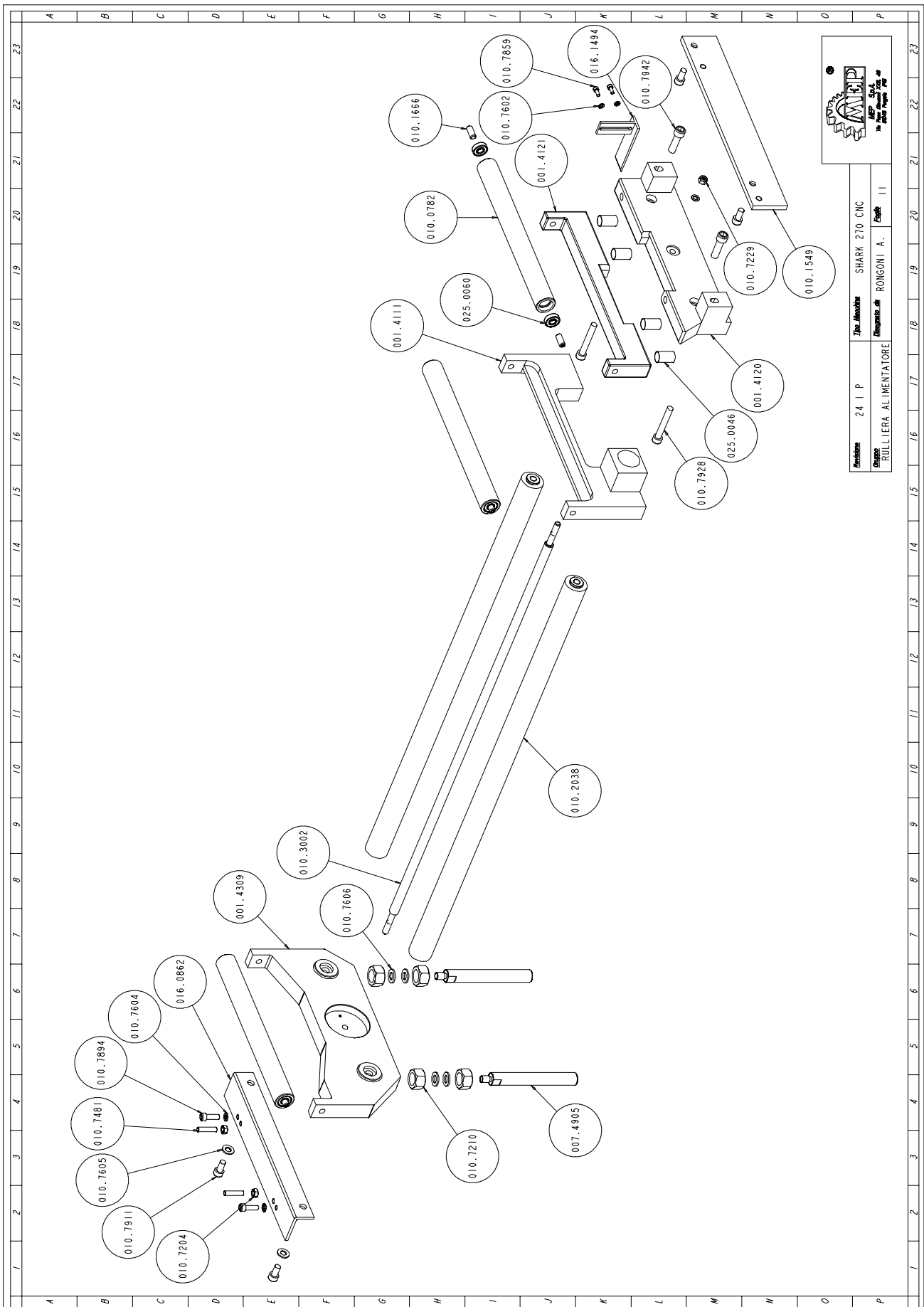

Art. NR.	Benaming	M.	Hoeveelheid
001.4111	SUPPORTO RULLO LIBERO ALIMENTATORE	NR	1,000
001.4120	.STAFFA ANT.PARTE INF. ALIMENTATORE	NR	1,000
001.4121	STAFFA ANT. PARTE SUP. ALIMENTATORE	NR	1,000
001.4309	STAFFA POSTERIORE ALIMENTATORE	NR	1,000
007.4905	SUPPORTO ALIMENTATORE SH 400	NR	2,000
010.0782	RULLO ALIMENTATORE	NR	1,000
010.1549	STAFFA FISSAGGIO ALIMENTATORE	NR	1,000
010.2038	GUIDA CARRELLO ALIMENTATORE	NR	2,000
010.3002	VITE RULLATA RS1610-15 L.979	NR	1,000
010.7204	DADO M8	NR	2,000
010.7210	DADO M22	NR	4,000
010.7229	DADO AUTOBLOCCANTE M8	NR	2,000
010.7481	GRANO VCE PUNTA PIANA 8 X 35	NR	2,000
010.7602	RONDELLA DIAM. 5	NR	2,000
010.7604	RONDELLA DIAM. 8	NR	4,000
010.7605	RONDELLA DIAM. 10	NR	2,000
010.7606	RONDELLA DIAM. 12	NR	4,000
010.7859	VITE TCEI 5 X 12	NR	2,000
010.7894	VITE TCEI 8 X 25	NR	2,000
010.7911	VITE TCEI 10 X 20	NR	4,000
010.7928	VITE TCEI 10 X 70	NR	2,000
010.7942	VITE TCEI 12 X 40	NR	4,000
016.0862	ADATTATORE CARICO	NR	1,000
016.1494	STAFFA COMANDO MICROINTERRUTTORE	NR	1,000
025.0060	CUSCINETTO 6000 2Z	NR	2,000