

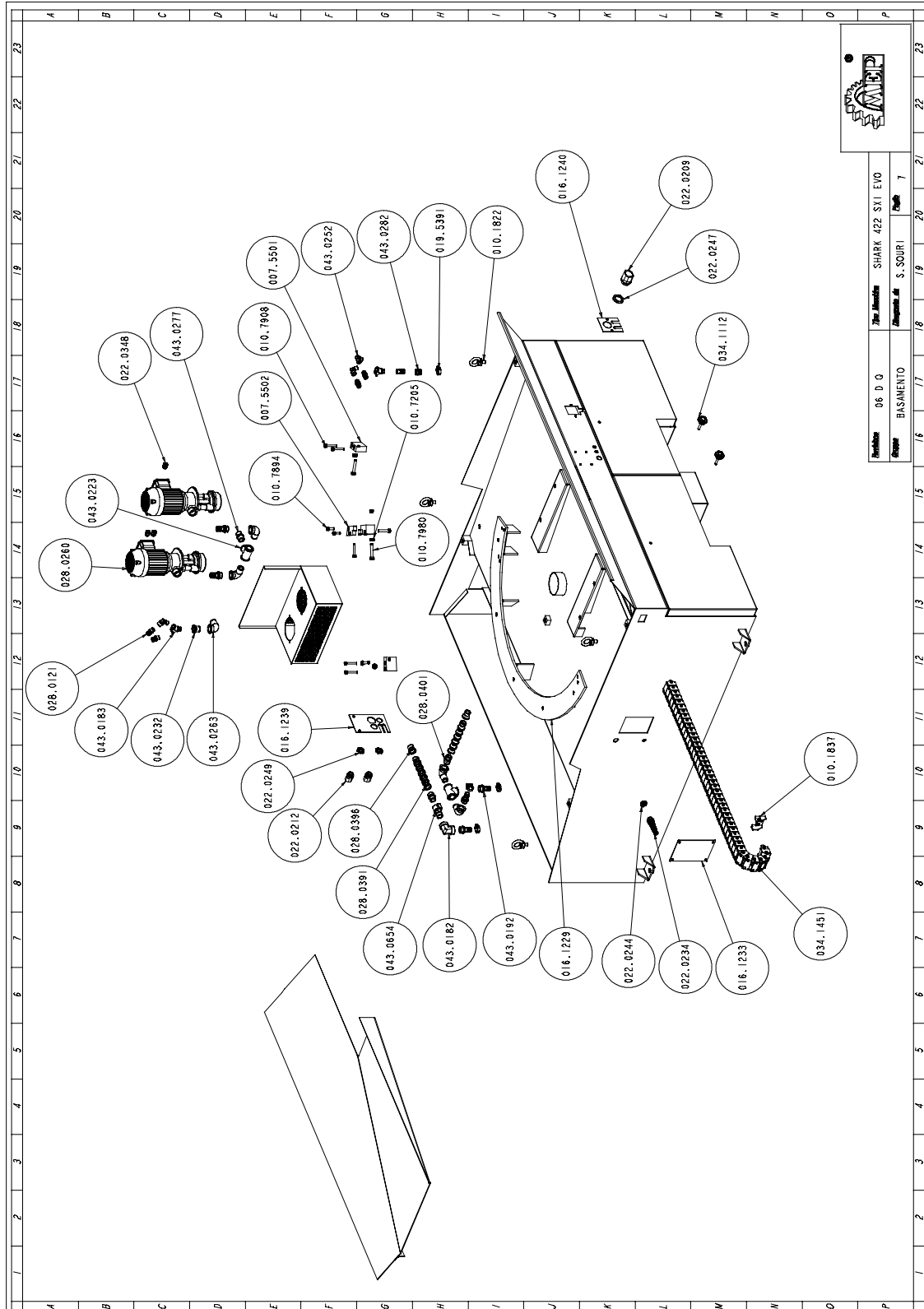

# Explosietekeningen

In het nu volgende deel zijn de explosietekeningen van de machine opgenomen. De tekeningen met hun volledige details kunnen helpen de machine beter te leren kennen.

## Onderkastgroep



	
Model	SHARK 422 SXI EVO
Stapel	BASAMENTO
Stapel	S. SOURI
Bladz.	7

<b>Art. NR.</b>	<b>Benaming</b>	<b>M.</b>	<b>Hoeveelheid</b>
007.5501	TASSELLO-BATT-45SX-60DX-SH420.PRT	NR	2
007.5502	TASSELLO-BATTUTA-45DX-SH420.ASM	NR	1
010.1822	GOLFARE-MASCHIO-M12-ZIN-SH420.PRT	NR	4
010.1837	SET-ATTACCHI-AX-CNC-NT.PRT	NR	1
010.7205	DADO-M10.PRT	NR	3
010.7221	DADO-M16-BASSO.PRT	NR	4
010.7229	DADO-AUTOB-M8.PRT	NR	1
010.7603	ROSETTA-6_4X12_5.PRT	NR	2
010.7868	M6X12-TCEI.PRT	NR	2
010.7894	M8X25-TCEI.PRT	NR	2
010.7908	M8X50-TCEI.PRT	NR	6
010.7980	M10X60-TE.PRT	NR	3
010.7995	M6X16-TSPEI.PRT	NR	5
010.9125	M8X60-VCEI-P.PRT	NR	2
013.0180	PIEDISTALLO-SHARK-420.ASM	NR	1
016.1229	PIASTRA-DI-ROTAZIONE.PRT	NR	1
016.1233	PIASTRA-COP-INTERR-SH331CCS.PRT	NR	1
016.1239	MOSTRINA-POST-SH422-SXI-EVO.PRT	NR	1
016.1240	MOSTRINA-ANTERIORE-BAS-SXI-EVO.PRT	NR	1
019.5391	FASCETTA-MINUS-GT-16X25.PRT	NR	4
022.0209	PG-29-KIEPE.PRT	NR	1
022.0212	PG-16-KIEPE.PRT	NR	2
022.0234	PASSACAVO-PG13_5.PRT	NR	1
022.0244	DADO-PASSACAVO-PG13_5.PRT	NR	1
022.0247	DADO-POLIAM-HUMMEL-262-2900-11.PRT	NR	1
022.0249	DADO-PASSACAVO-PG16.PRT	NR	2
022.0348	ADATTATORE-16-11-M16PG11.PRT	NR	3
028.0121	RACCORDO-3_8-17CL2601.PRT	NR	5
028.0260	ELETTROPOMPA-LPA25_120KW037V230.PRT	NR	2
028.0391	TUBO-LOOC-LINE-SPD-3_4.PRT	NR	2
028.0396	UGELLO-0-20SPD-FP50-11B50.PRT	NR	2
028.0401	RACCORDO-3_4SPD-FP50-11B50.PRT	NR	2
034.0901	TAPPO-LIVELLO-OLIO-1_2-GAS.PRT	NR	1
034.1112	VOLANTINO-DIA_40M8XPIED_SH-CO33.PRT	NR	2
034.1451	CATENA-PORTAC-17-04-63-0-AX-CNC.ASM	NR	1
043.0182	RACCORDO-A-GOMITO-FF-3_4ZINCATO.PRT	NR	1
043.0183	RACCORDO-A-Y-90-3_8.PRT	NR	2
043.0192	RACCORDO-RB-9889-3_4X20.PRT	NR	5
043.0223	RACCORDO-TE-FFF-3_4-ZINCATO.PRT	NR	2
043.0232	RIDUZIONE-ZINCATA-3_4.PRT	NR	1
043.0252	GOMITO-MF3_8CL2020.PRT	NR	3
043.0263	RACCORDO-A-GOMITO-MF-ZINCATO3_4.PRT	NR	5
043.0277	NIPPLO-CONICO-ZINCATO-3_4-IDR.PRT	NR	1
043.0282	MANICOTTO-3_8.PRT	NR	1
043.0654	RUBINETTO-MF-3_4.PRT	NR	1



Art. NR.	Benaming	M.	Hoeveelheid	
001.4454	SQUADRO-MORSA-SX-SH420.PRT	NR	1	
001.4455	SQUADRO-MORSA-DX-SH420.PRT	NR	1	
007.4536	PERNO-PFISSO.PRT	NR	1	
007.4601	CLINDRETTO-PFISSO.PRT	NR	1	
007.5031	SQUADRETTO-LIQU-PIANO-GIR-SH400.PRT	NR	2	
007.5325	PERNO-BLOC-PIANO-GIREV-SH420SXI.PRT	NR	1	
007.5442	GANASCIA-FISSA-SINISTRA-SH420.PRT	NR	1	
007.5443	GANASCIA-FISSA-DESTRA-SH420SXI.PRT	NR	1	
007.5485	PIANO-APPOG-BARRA-SUPPLEM-PRT2.PRT	NR	1	
007.6675	PIANO-APPOG-BARRA-SUPPL-1-NT.PRT	NR	2	
010.0902	MOLLA-PFISSO.PRT	NR	1	
010.1204	OLIATORE-A-SFERA-DIA6.PRT	NR	2	
010.1804	CHIUSURA-X-RULLIERA-DX-SH420SXI.PRT	NR	1	
010.1805	CHIUSURA-X-RULLIERA-SX-SH420SXI.PRT	NR	1	
010.2815	GUIDA COMPLETA DI PATTINI-HIWIN-LGR-25-640.PRT	NR	2	
010.7475	M8X8-VCEI-P.PRT	NR	1	
010.7480	M8X30-VCEI-P.PRT	NR	2	
010.7604	ROSETTA-8_4X14.PRT	NR	8	
010.7870	M6X16-TCEI.PRT	NR	4	
010.7872	M6X25-TCEI.PRT	2	NR	2
010.7873	M6X30-TCEI.PRT	NR	4	
010.7891	M8X16-TCEI.PRT	NR	4	
010.7893	M8X20-TCEI.PRT	NR	4	
010.7912	M10X35-TCEI.PRT	NR	4	
010.7939	M12X25-TCEI.PRT	NR	2	
010.7942	M12X40-TCEI.PRT	NR	2	
010.7960	M8X16-TE.PRT	NR	4	
010.8503	SPINA-CIL-10X25.PRT	NR	2	
010.8621	SPINA-CIL-8X40.PRT	NR	2	
016.1485	STAFFA-FIX-RULLIERA-DX-SH420.PRT	NR	1	
016.1486	STAFFA-FIX-RULLIERA-SX-SH420.PRT	NR	1	
016.1595	PROLUNGA-GAN-DX-SH420SXI.PRT	NR	1	
016.1596	PROLUNGA-GAN-SX-SH420SXI.PRT	NR	1	
025.0452	RULLINO-6X6AISI420.PRT	NR	1	
028.0010	PISTOLA.PRT	NR	1	
028.0121	RACCORDO-3_8-17CL2601.PRT	NR	2	
028.0394	TUBO-LOOC-LINE-59861-1_2.PRT	NR	2	
028.0399	UGELLO-12-7-ART59861.PRT	NR	2	
028.0404	RACCORDO3_8-NPT-LOOC-LINE-1_2.PRT	NR	2	
034.1002	LEVA-SCATTO-M10.PRT	NR	1	
034.1110	VOLANTINO-DIAM30M6X10.PRT	NR	1	
034.1203	VOL-M10-PFISSO.PRT	NR	1	
043.0186	RACCORDO-FEMMINA1_2AQUASTOP.PRT	NR	1	
043.0252	GOMITO-MF3_8CL2020.PRT	NR	4	
043.0653	RUBINETTO-MF-3_8-CL6310.PRT	NR	2	



<b>Art. NR.</b>	<b>Benaming</b>	<b>M.</b>	<b>Hoeveelheid</b>
001.4451	PIATTAFORMA-ROTANTE-SH420-SE.PRT	NR	1
007.4823	PERNO-SNODO-ARCHETTO-SH400.PRT	NR	1
007.5102	DIST-CUSCINET-SNODO-TESTA-SH400.PRT	NR	2
007.5326	PERNO-DI-CENTRO-SH420SXI.PRT	NR	1
007.5327	PERNO-CUSCIN-AMMORT-SH420SXI.PRT	NR	2
007.5391	BUSS-PERNO-SNODO-TESTA-SH420.PRT	NR	2
007.5392	BUSSOLA-GANASCE-SQUADR-SH420SXI.PRT	NR	1
007.5393	BUSSOLA-RASCHIAPOLVERE-SH420SXI.PRT	NR	2
007.5481	PIASTRA-DI-TAGLIO-SH420SXI.PRT	NR	1
010.0356	GHIERA-45-15.PRT	NR	2
010.0362	GHIERA-50-15.PRT	NR	1
010.0895	MOLLA-AMMORTIZZATORI-SH420SXI.PRT	NR	2
010.0896	MOLLA-STIL-RIC-TESTA-SH400.PRT	NR	2
010.1104	FORCELLA-CUSCINETTI-SH420SXI.PRT	NR	2
010.1151	AMMORTIZZATORE-DX-SH420SXI.PRT	NR	1
010.1152	AMMORTIZZATORE-SX-SH420SXI.PRT	NR	1
010.1223	SPINA-CEMENTATA-10X32-SH420.PRT	NR	2
010.1523	STAF-AGG-DOP-MOL-PIAT-FIX-SH400.PRT	NR	1
010.3164	BATTUTA-FINE-CORSA-TESTA-SH400.PRT	NR	1
010.7205	DADO-M10.PRT	NR	1
010.7208	DADO-M16.PRT	NR	1
010.7604	ROSETTA-8_4X14.PRT	NR	4
010.7605	ROSETTA-10_5X21.PRT	NR	6
010.7858	M5X10-TCEI.PRT	NR	6
010.7894	M8X25-TCEI.PRT	NR	4
010.7925	M10X40-TCEI.PRT	NR	2
010.7972	M16X60-TE.PRT	NR	1
010.7977	M10X35-TE.PRT	NR	4
010.7978	M10X40-TE.PRT	NR	1
010.8909	M10X95-TE.PRT	NR	2
010.9118	M6X6-VCEI-P.PRT	NR	6
025.0054	6203-2Z.PRT	NR	4
025.0193	ANELLO-OR-158.PRT	NR	2
025.0221	ANELLO-OR-176.PRT	NR	2
025.0246	ANELLO-OR-3187.PRT	NR	1
025.0276	NILOS-32011X.PRT	NR	2
025.0922	32011X.PRT	NR	2
025.0931	RALLA-GS81110.PRT	NR	1
025.0932	RALLA-WS81110.PRT	NR	1
025.0933	GABBIA-ASSIALE-K81110.PRT	NR	1
028.0370	BARRETTA-VULCAN-TIPO-VAJ-SH420.PRT	NR	2

# Klem groep

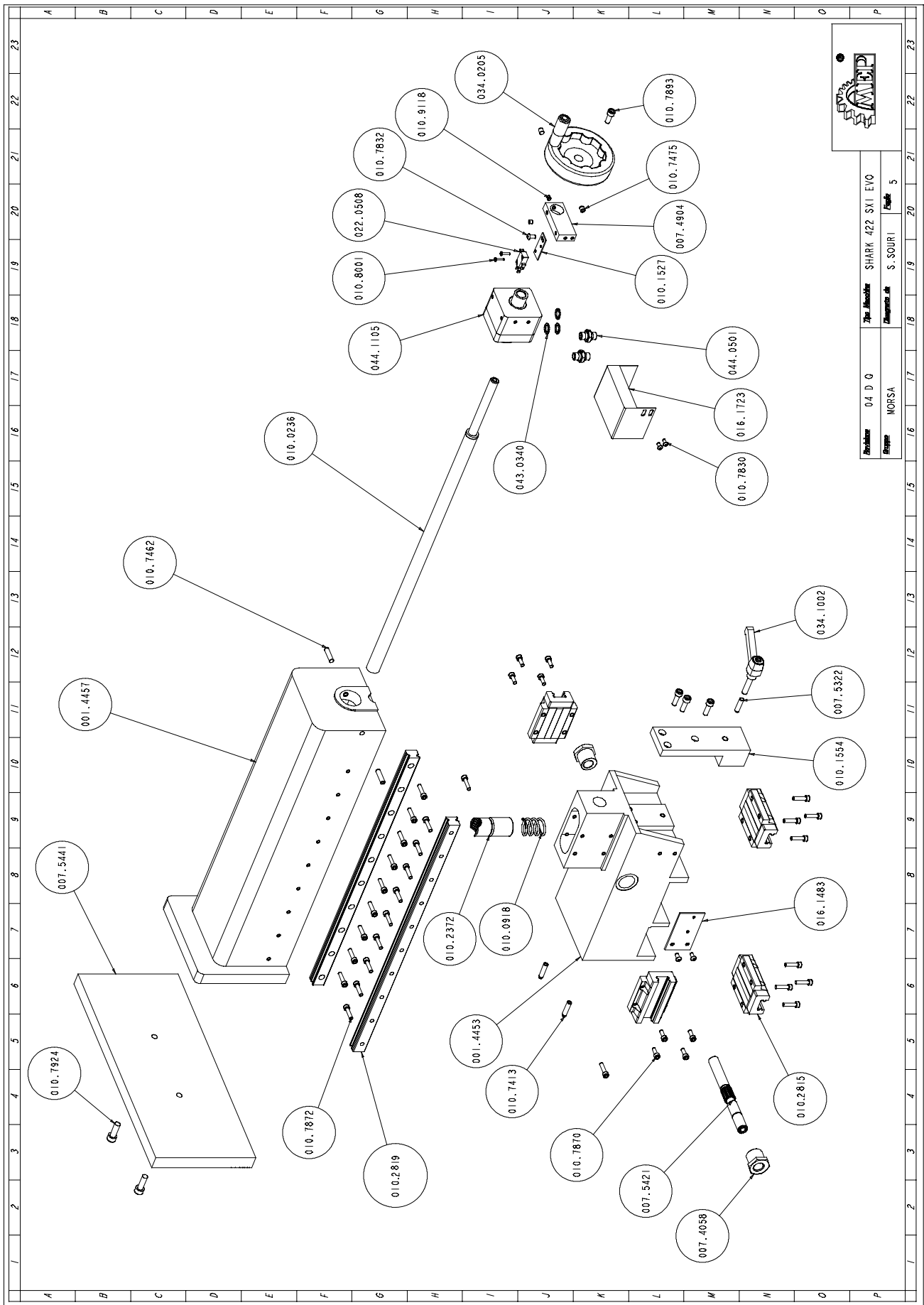

<b>Art. NR.</b>	<b>Benaming</b>	<b>M.</b>	<b>Kvantum</b>
001.4457	SCORREVOLE-MORSA-SH420.PRT	NR	1
001.4453	SUPP-SCORREVOLE-MORSA-SH420.PRT	NR	1
007.4058	007_4058.PRT	NR	2
007.4904	STAF-SUP-FC-PRES-BARRA-SH400.PRT	NR	1
007.5322	PERNO-STAF-BLOC-MORSA-SH420SXI.PRT	NR	1
007.5421	PIGNONE-SBLOC-SCORR-SH420SXI.PRT	NR	1
007.5441	GANASCIA-MORSA-MOB-SH420SXI.PRT	NR	1
010.0236	VITE-MORSA-SH420-NEW.PRT	NR	1
010.0918	010_0918.PRT	NR	1
010.1527	STAFFA-FIX-FC-PRES-BARRA-SH400.PRT	NR	1
010.1554	STAFF-BLOC-MORSA-TAGL-SH420SXI.PRT	NR	1
010.2372	CHIOCCIOLA-MORSA-SH260-280-320.ASM	NR	1
010.2819	GUIDE COMPLETE DI PATTINI 580 MM	NR	2
010.7413	M8X30-VCEI-PR.PRT	NR	2
010.7454	M8X8-VCEI-PC.PRT	NR	1
010.7462	M8X30-VCEI-PC.PRT	NR	2
010.7475	M8X8-VCEI-P.PRT	NR	1
010.7491	M10X60-VCEI-P.PRT	NR	1
010.7830	M5X10-BUTTO.PRT	NR	2
010.7832	M6X12-BUTTO.PRT	NR	3
010.7859	M5X12-TCEI.PRT	NR	4
010.7870	M6X16-TCEI.PRT	NR	8
010.7872	M6X25-TCEI.PRT	NR	8
010.7893	M8X20-TCEI.PRT	NR	1
010.7894	M8X25-TCEI.PRT	NR	7
010.7924	M10X30-TCEI.PRT	NR	2
010.8001	VITE-TCIC-M3X16.PRT	NR	2
010.9118	M6X6-VCEI-P.PRT	NR	2
016.1483	STAFFA-FIX-CATENA-SH420.PRT	NR	1
016.1723	PROT-FC-ALIM-PRES-BARRA-SH400.PRT	NR	1
022.0508	FINE-CORSA-V5B010-CB1.PRT	NR	1
025.0203	ANELLO-35X25X7.PRT	NR	2
025.0217	ANELLO-OR-155.PRT	NR	1
025.0452	RULLINO-6X6AISI420.PRT	NR	1
010.2815	PATTINO COMPLETO DI GUIDA 640 MM-LGW25HCZ3C.PRT	NR	4
034.0205	VOLANTINO-MORSA-125.PRT	NR	1
034.1002	LEVA-SCATTO-M10.PRT	NR	1
043.0340	RONDELLA-RAME-1_4.PRT	NR	3
044.0501	NIPPLO-NP-1_4-IDRAULICO.PRT	NR	2
044.1105	CILINDRO-VOLAMPRESS-D-E-SH400.ASM	NR	1



## Doorsnede-aandrijfwiel groep

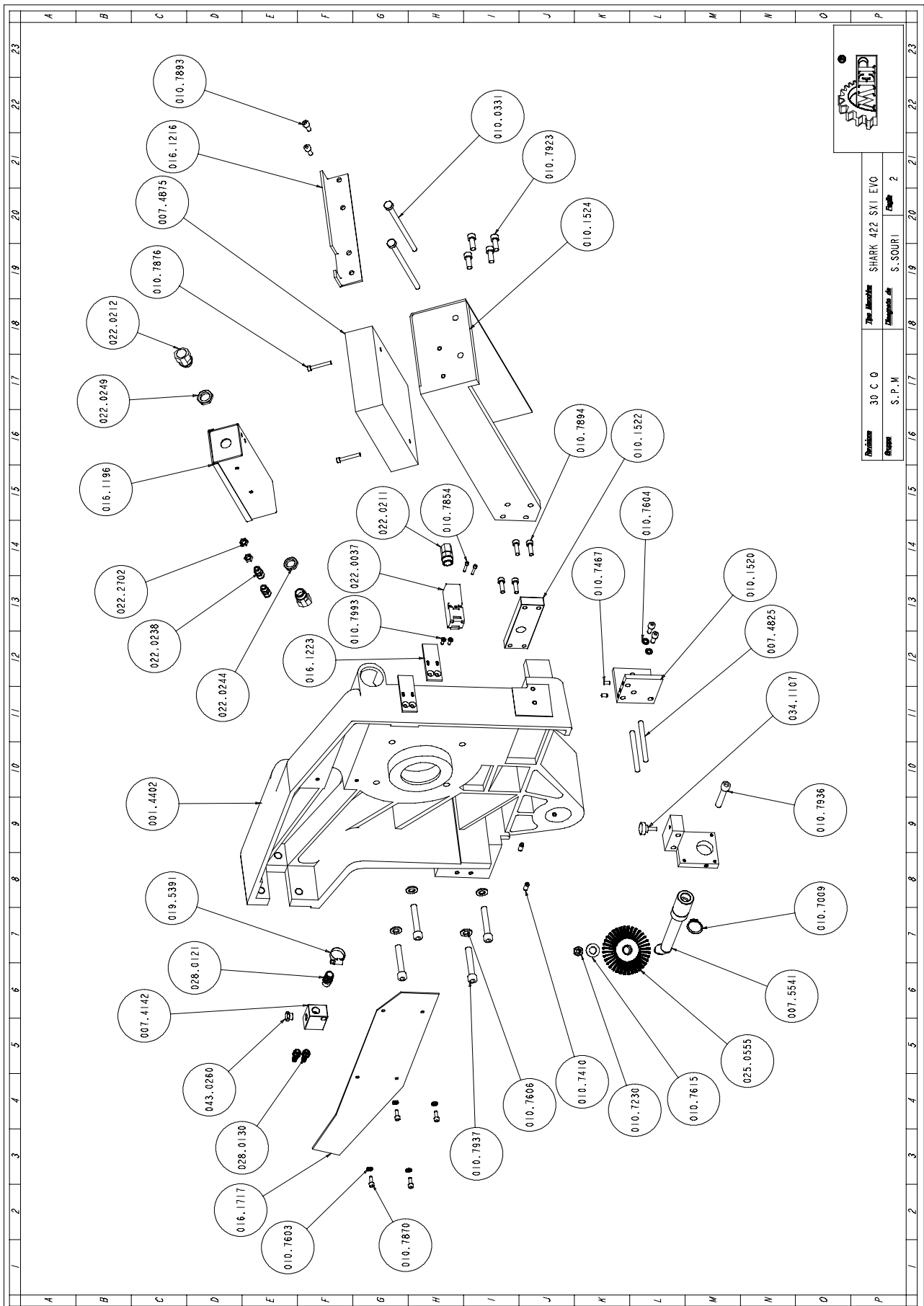

		30 C Q	30 C Q	Theil Nummer	SHARK 422 SXI EVO
		S.P.M	S.P.M	Diagramma nr.	S. SOURI

<b>Art. NR.</b>	<b>Benaming</b>	<b>M.</b>	<b>Hoeveelheid</b>
001.4402	SPM-TI-REX400.PRT	NR	1
007.4142	SQUADRETTO-LIQUIDO-SH320-330.PRT	NR	1
007.4825	PERNO-DI-SCOR-MOTORE-PULI-SH400.PRT	NR	2
007.4875	PIASTRA-BILANCIATRICE-SH400.PRT	NR	1
007.5541	ALBERO-PORT-PULILAMA-SH420-SXI.ASM	NR	1
010.0331	VITE-MOLLA-SNODO-TESTA-SH400.PRT	NR	2
010.1520	STAFFA-REG-SPAZZOLA-MOTOR-SH400.PRT	NR	1
010.1522	STAFFA-ESTERNA-CILINDRO-SH400.PRT	NR	1
010.1524	STAFFA-AGG-DOP-MOLLA-SPM-SH400.ASM	NR	1
010.7009	SEEGER-30.PRT	NR	1
010.7230	DADO-AUTOB-M10.PRT	NR	1
010.7410	M8X16-VCEI-PR.PRT	NR	2
010.7467	M6X12-VCEI-P.PRT	NR	2
010.7603	ROSETTA-6_4X12_5.PRT	NR	4
010.7604	ROSETTA-8_4X14.PRT	NR	2
010.7606	ROSETTA-13X24.PRT	NR	4
010.7615	ROSETTA-15X28.PRT	NR	1
010.7854	M4X25-TCEI.PRT	NR	2
010.7870	M6X16-TCEI.PRT	NR	4
010.7876	M6X45-TCEI.PRT	NR	2
010.7893	M8X20-TCEI.PRT	NR	4
010.7894	M8X25-TCEI.PRT	NR	4
010.7923	M10X25-TCEI.PRT	NR	4
010.7936	M12X65-TCEI.PRT	NR	1
010.7937	M12X70-TCEI.PRT	NR	4
010.7993	M5X12-TSPEI.PRT	NR	2
016.1196	SCATOLA-DERIV-SHSXINT.ASM	NR	1
016.1216	STAFFA-FIX-GUAINA-SH420.PRT	NR	1
016.1223	016_1223.PRT	NR	2
016.1717	PROTEZIONE-CAVI-SPM-SH400.PRT	NR	1
019.5391	FASCETTA-MINUS-GT-16X25.PRT	NR	1
022.0037	022_0037.PRT	NR	1
022.0211	PG-13_5-KIEPE.PRT	NR	2
022.0212	PG-16-KIEPE.PRT	NR	1
022.0238	PRESSACAVO-PG7-BS01.PRT	NR	2
022.0244	DADO-PASSACAVO-PG13_5.PRT	NR	1
022.0249	DADO-PASSACAVO-PG16.PRT	NR	1
022.2702	DADO-PG7-BL01.PRT	NR	2
025.0555	SPAZ-PULILAMA-3103-0-100-SH400.PRT	NR	1
028.0121	RACCORDO-3_8-17CL2601.PRT	NR	1
028.0130	RACCORDO-1_4-9_CL2601.PRT	NR	2
034.1107	VOLANTINO-DIAM30M6X20.PRT	NR	1
043.0260	TAPPO-TTE4-1_4-CL2611.PRT	NR	1

### Achterste-zaagbandgeleideblokje groep

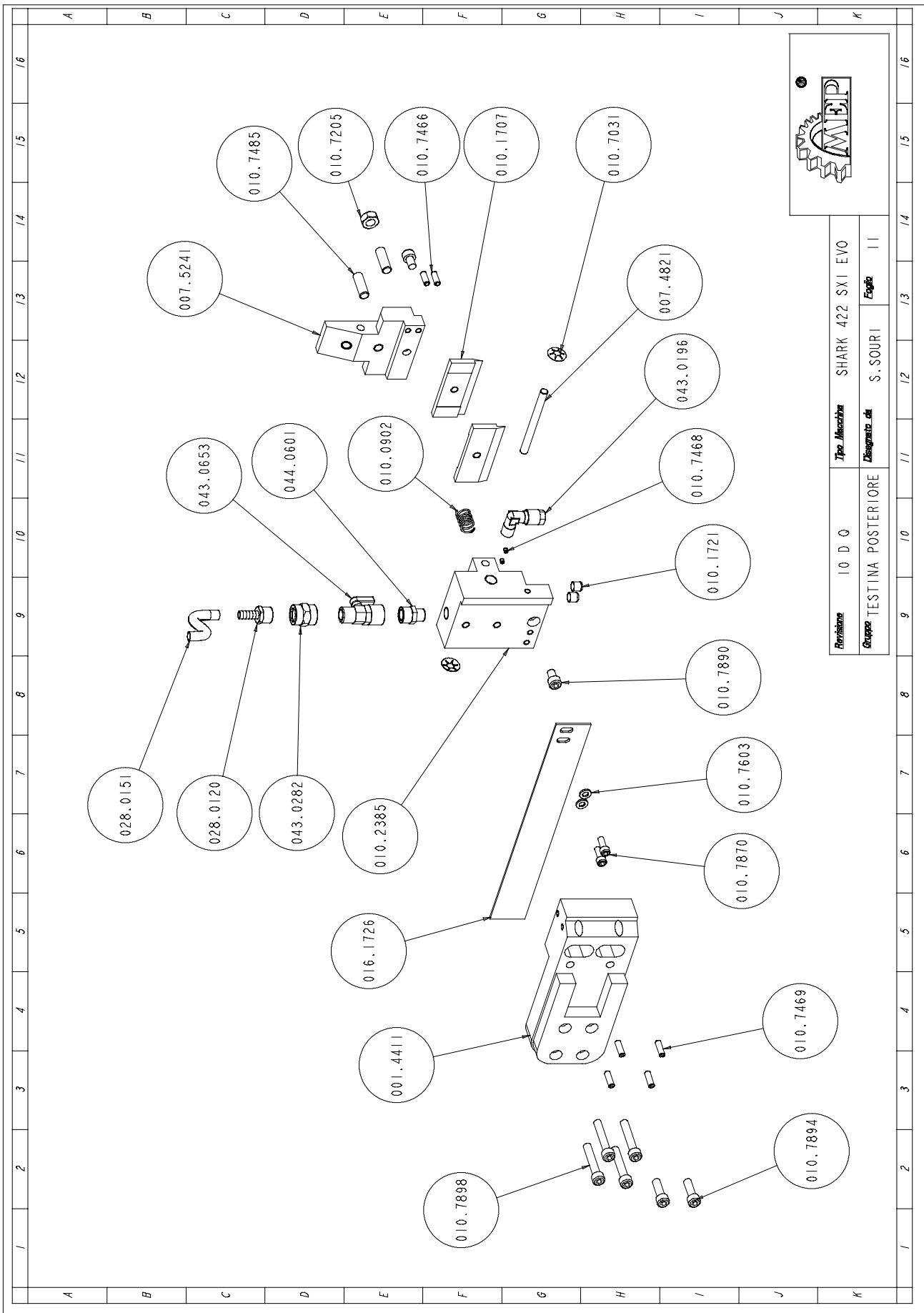

<b>Art. NR.</b>	<b>Benaming</b>	<b>M.</b>	<b>Hoeveelheid</b>
001.4411	STAFFA-TESTINA-POST-SH400.PRT	NR	1
007.4821	PERNO-SNODO-TESTINA-SH400.PRT	NR	1
007.5241	TES-GUID-POST-MOBILE-SH400-NT.PRT	NR	1
010.0902	MOLLA-PFISSO.PRT	NR	1
010.1719	GUIDALAMA-SH400.PRT	NR	2
010.1721	BOTTONE.PRT	NR	2
010.2385	TES-GUID-POST-FISSA-SH400.PRT	NR	1
010.7031	ANELLO-SEEGER-SK8.PRT	NR	2
010.7205	DADO-M10.PRT	NR	1
010.7466	M6X16-VCEI-P.PRT	NR	2
010.7468	M4X4-VCEI-P.PRT	NR	2
010.7469	M6X20-VCEI-P.PRT	NR	4
010.7485	M10X30-VCEI-P.PRT	NR	2
010.7603	ROSETTA-6_4X12_5.PRT	NR	2
010.7870	M6X16-TCEI.PRT	NR	2
010.7890	M8X12-TCEI.PRT	NR	2
010.7894	M8X25-TCEI.PRT	NR	2
010.7898	M8X45-TCEI.PRT	NR	4
016.1726	PROT-LAMA-POST-SH400.PRT	NR	1
028.0120	RACCORDO-3_8-9_CL2601.PRT	NR	1
028.0151	TUBO-PLASTIFICATO-07-11.PRT	NR	1
043.0196	RACCORDO-GOMITO-MF8X1_4CL1020.PRT	NR	1
043.0282	MANICOTTO-3_8.PRT	NR	1
043.0653	RUBINETTO-MF-3_8-CL6310.PRT	NR	1
044.0601	RIDUZIONE-MMRC-3_8-1_4.PRT	NR	1

### Motor groep

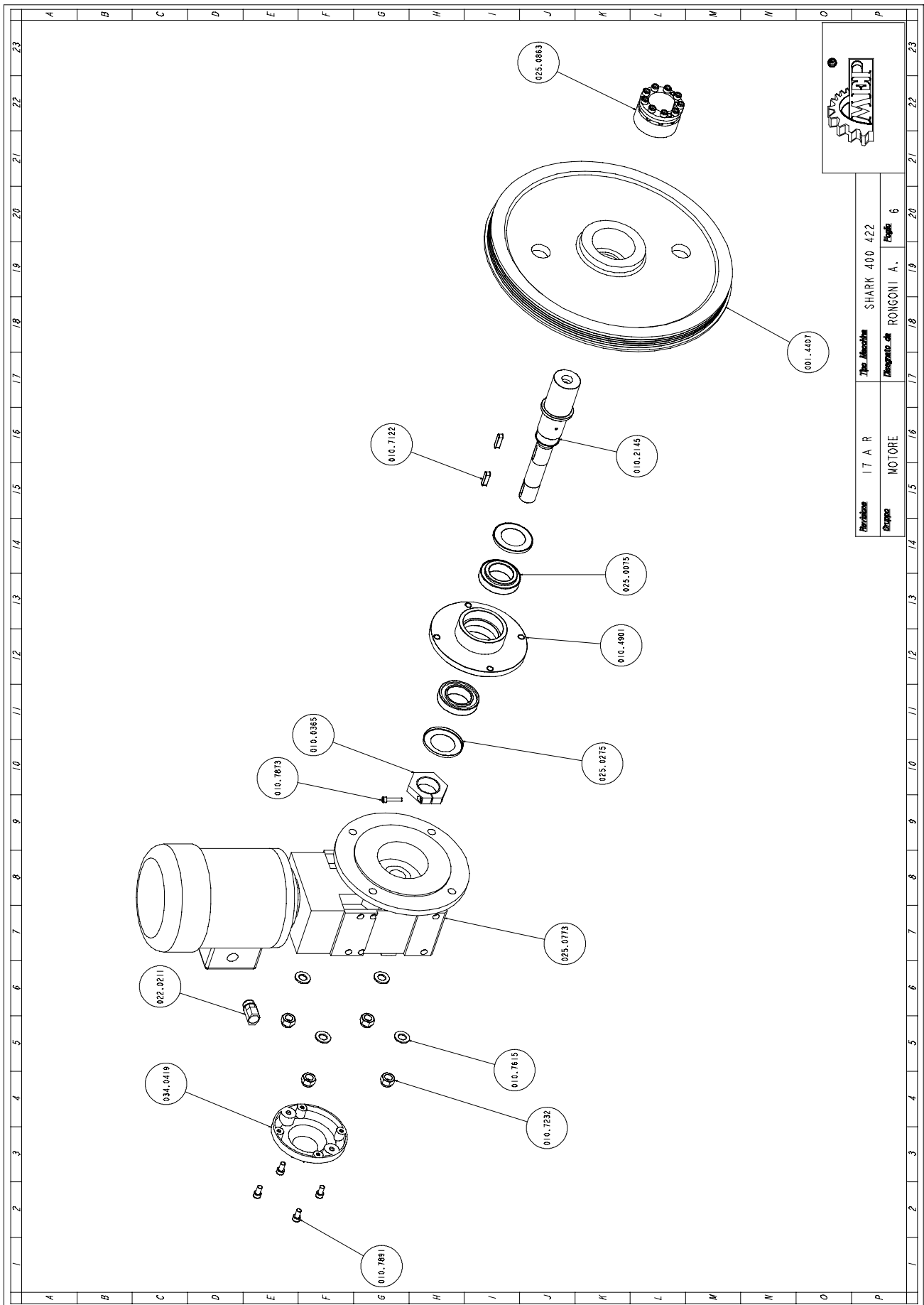

<b>Art. NR.</b>	<b>Benaming</b>	<b>M.</b>	<b>Hoeveelheid</b>
001.4407	PULEGGIA MOTRICE	NR	1,000
010.0365	GHIERA ALBERO MOTORE	NR	1,000
010.2145	ALBERO RIDUTTORE	NR	1,000
010.4901	TAMPONE ALBERO RIDUTTORE	NR	1,000
010.7122	CHIAVETTA 8 X 8 X 32	NR	2,000
010.7232	DADO AUT. M14	NR	4,000
010.7615	RONDELLA DIAM. 15	NR	4,000
010.7873	VITE TCEI 6 X 30	NR	1,000
010.7891	VITE TCEI 8 X 16	NR	4,000
022.0211	RACCORDO RAPIDO SEM PG 13,5	NR	1,000
025.0075	CUSCINETTO 32009X	NR	2,000
025.0275	ANELLO DI PROTEZIONE NILOS 32009X	NR	2,000
025.0773	MOTORIDUTTORE A 20 2 F1C 53,7 S3	NR	1,000
025.0863	CALETTATORE TLK 130 50X80	NR	1,000
034.0419	COPERCHIO RIDUTTORE SH 320	NR	1,000

### Dwarsbalk groep

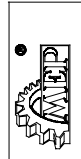
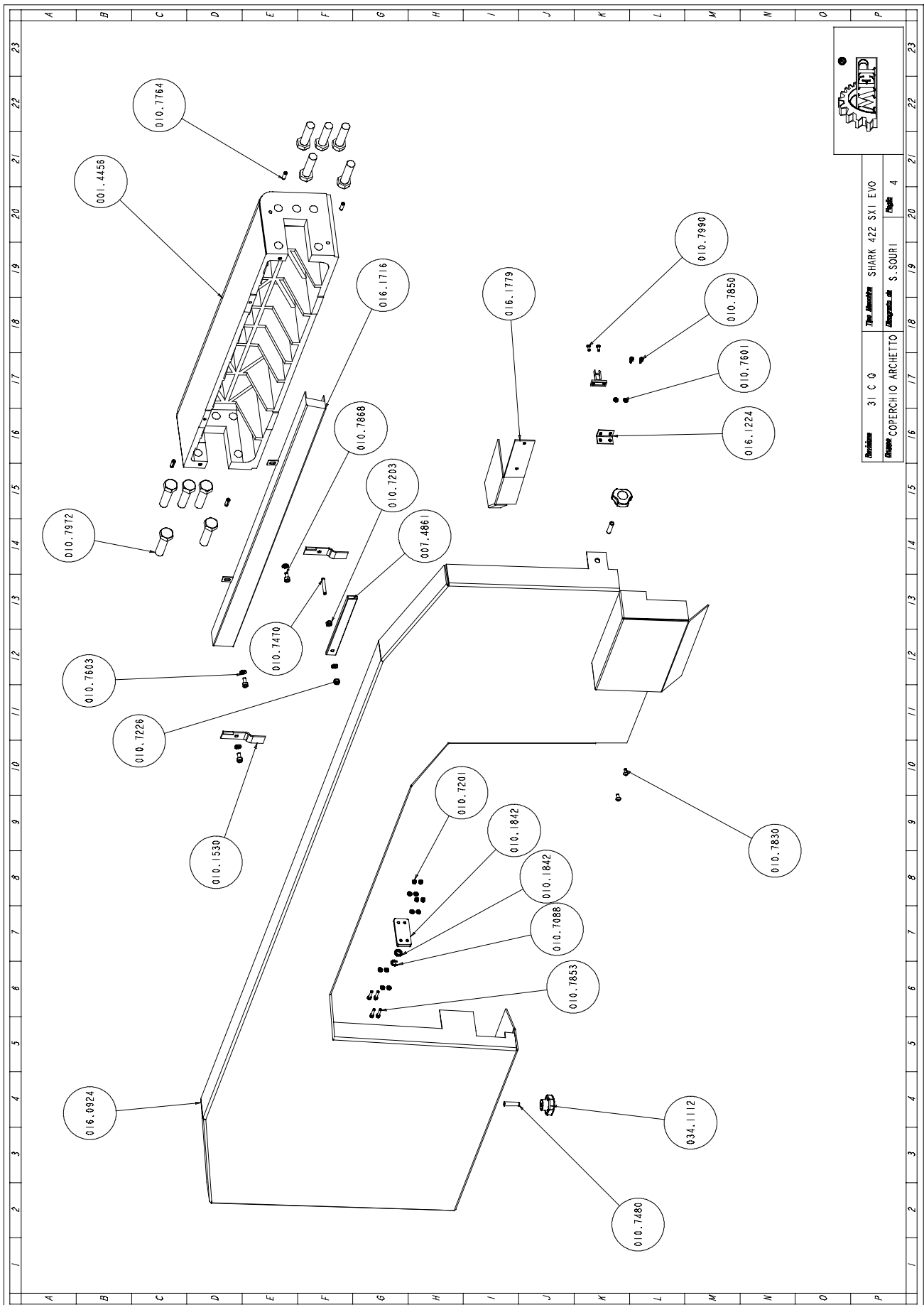

Model	SHARK 422 SXI EVO
Titel	SHARK 422 SXI EVO
Ontwerper	S. SQUERI
Bladzijde	4

<b>Art. NR.</b>	<b>Benaming</b>	<b>M.</b>	<b>Hoeveelheid</b>
001.4456	TRAVE-ARCHETTO-SH420.PRT	NR	1
007.4861	SOSTEGNO-COPERCHIO-ARCHET-SH400.PRT	NR	1
010.1530	STAFFA-DI-FERMO-SH400.PRT	NR	2
010.1842	SUP-MASCHIO-X-MOLLA-A-GAS-DIST.PRT	NR	1
010.1842	SUPPORTO-MASCHIO-X-MOLLA-A-GAS.PRT	NR	1
010.7088	ANELLO-ELA-ESP-7.PRT	NR	1
010.7201	DADO-M4.PRT	NR	4
010.7203	DADO-M6.PRT	NR	1
010.7226	DADO-AUTOB-M6.PRT	NR	1
010.7470	M6X35-VCEI-P.PRT	NR	1
010.7480	M8X30-VCEI-P.PRT	NR	2
010.7601	ROSETTA-4_1X9.PRT	NR	0
010.7603	ROSETTA-6_4X12_5.PRT	NR	4
010.7764	SPINA-ELASTICA-6X20.PRT	NR	4
010.7830	M5X10-BUTTO.PRT	NR	2
010.7850	M4X8-TCEI.PRT	NR	2
010.7853	M4X20-TCEI.PRT	NR	4
010.7868	M6X12-TCEI.PRT	NR	3
010.7972	M16X60-TE.PRT	NR	0
010.7990	M4X8-TSPEI.PRT	NR	2
016.0924	COPERCHIO-ARCHETTO-SH420.ASM	NR	1
016.1224	PIASTRA-FISS-INTERR-COP-SH.PRT	NR	1
016.1716	PROTEZIONE-CAVI-TRAVE-SH400.PRT	NR	1
016.1779	PROT-LAMA-POST-SH400-NT.PRT	NR	1
034.1112	VOLANTINO-DIA_40M8XPIED_SH-CO33.PRT	NR	2



### Doorsnede-loopwiel groep

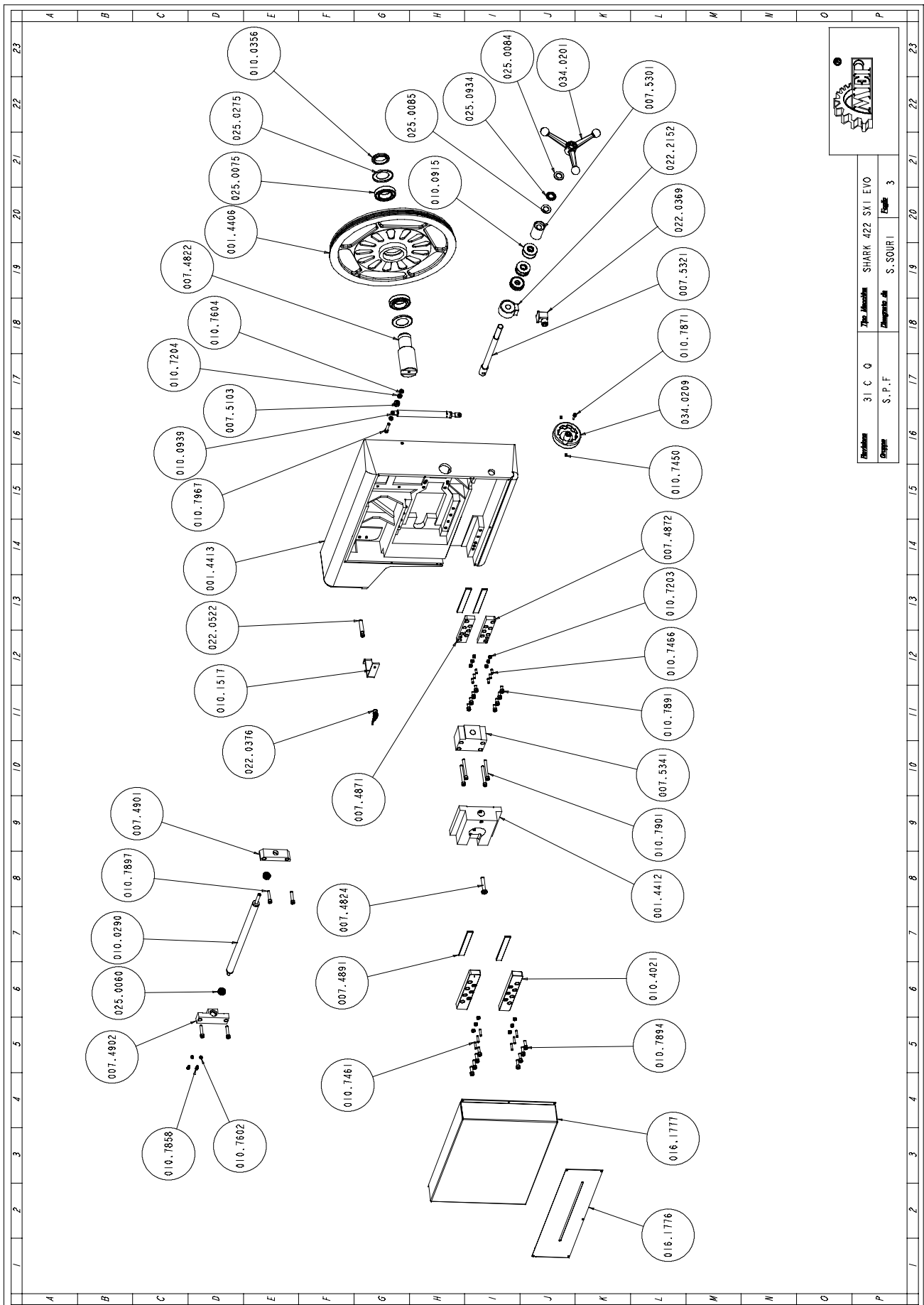

Model	31 C 0
The Machine	SHARK 422 SXI EVO
Group	S.P.F.
Manufacturer	S.SOURI
Scale	3

<b>Art. NR.</b>	<b>Benaming</b>	<b>M.</b>	<b>Hoeveelheid</b>
001.4412	SLITTA-TENDILAMA-SH400.PRT	NR	1
001.4406	PULEGGIA-FOLLE-SHARK400.PRT	NR	1
001.4413	SPF-SH422.PRT	NR	1
007.4822	PERNO-PULEGGIA-FOLLE-SH400.PRT	NR	1
007.4824	PERNO-BLOCC-CIL-TENS-LAMA-TR400.PRT	NR	1
007.4871	PIA-SUP-REG-LARD-SUP-TEST-SH400.PRT	NR	1
007.4872	PIA-INF-REG-LARD-SUP-TEST-SH400.PRT	NR	1
007.4891	LARD-SLIT-TEN-E-SUP-TEST-SH400.PRT	NR	4
007.4901	SUPP-POS-X-VITE-TRAS-TEST-SH400.PRT	NR	1
007.4902	SUPP-ANT-X-VITE-TRAS-TEST-SH400.PRT	NR	1
007.5103	DISTANZIALE-MOLLA-A-GAS-SH400.PRT	NR	1
007.5301	DISTANZ-TENSION-LAMA-SH420SXI.PRT	NR	1
007.5321	PERNO-TENSIONAM-LAMA-SH420SXI.PRT	NR	1
007.5341	SUPPORTO-TENS-LAMA-SH420SXI.PRT	NR	1
010.0290	VITE-SUP-TEST-GUID-SH420SXI.PRT	NR	1
010.0356	GHIERA-45-15.PRT	NR	1
010.0915	MOLLA-A-TAZZA-18-50-3.PRT	NR	6
010.0939	MOLLA-A-GAS300MM300N-SH400.PRT	NR	1
010.1517	STAFFA-FIX-PROXIMITY-SH400.PRT	NR	1
010.4021	PIAS-REG-SLITTA-LARDONE-SH320.PRT	NR	2
010.7203	DADO-M6.PRT 1	NR	2
010.7204	DADO-M8.PRT	NR	1
010.7450	M6X6-VCEI-PC.PRT	NR	2
010.7461	M6X25-VCEI-P.PRT	NR	6
010.7466	M6X16-VCEI-P.PRT	NR	6
010.7602	ROSETTA-5_3X10.PRT	NR	2
010.7604	ROSETTA-8_4X14.PRT	NR	2
010.7858	M5X10-TCEI.PRT	NR	2
010.7871	M6X20-TCEI.PRT	NR	1
010.7891	M8X16-TCEI.PRT	NR	8
010.7894	M8X25-TCEI.PRT	NR	8
010.7897	M8X40-TCEI.PRT	NR	4
010.7901	M8X75-TCEI.PRT	NR	4
010.7967	M8X40-TE.PRT	NR	1
016.1776	PROT-INF-SPF-SH422.PRT	NR	1
016.1777	PROT-SUP-SPF-SH422.PRT	NR	1
022.0369	TENSIONATORE-ELETTRON-COMP2.PRT	NR	1
022.0376	CONNETTORE-F303N5000XPROSSIMITI.PRT	NR	1
022.0522	PROXIMITY.PRT	NR	1
022.2152	TENSIONATORE-ELETTRON-COMP1.PRT	NR	1
025.0060	6000-2Z.PRT	NR	2
025.0075	32009X.PRT	NR	2
025.0084	RALLA-GS-81104.PRT	NR	1
025.0085	RALLA-WS-81104.PRT	NR	1
025.0275	NILOS-32009X.PRT	NR	2
025.0934	REGGISPINTA-K81104.PRT	NR	1
034.0201	VOLANTINO-MORSA-GRANDE.PRT	NR	1
034.0209	VOL-MORSA-D100-FORATO.PRT	NR	1

### Voorste-geleideblokje groep

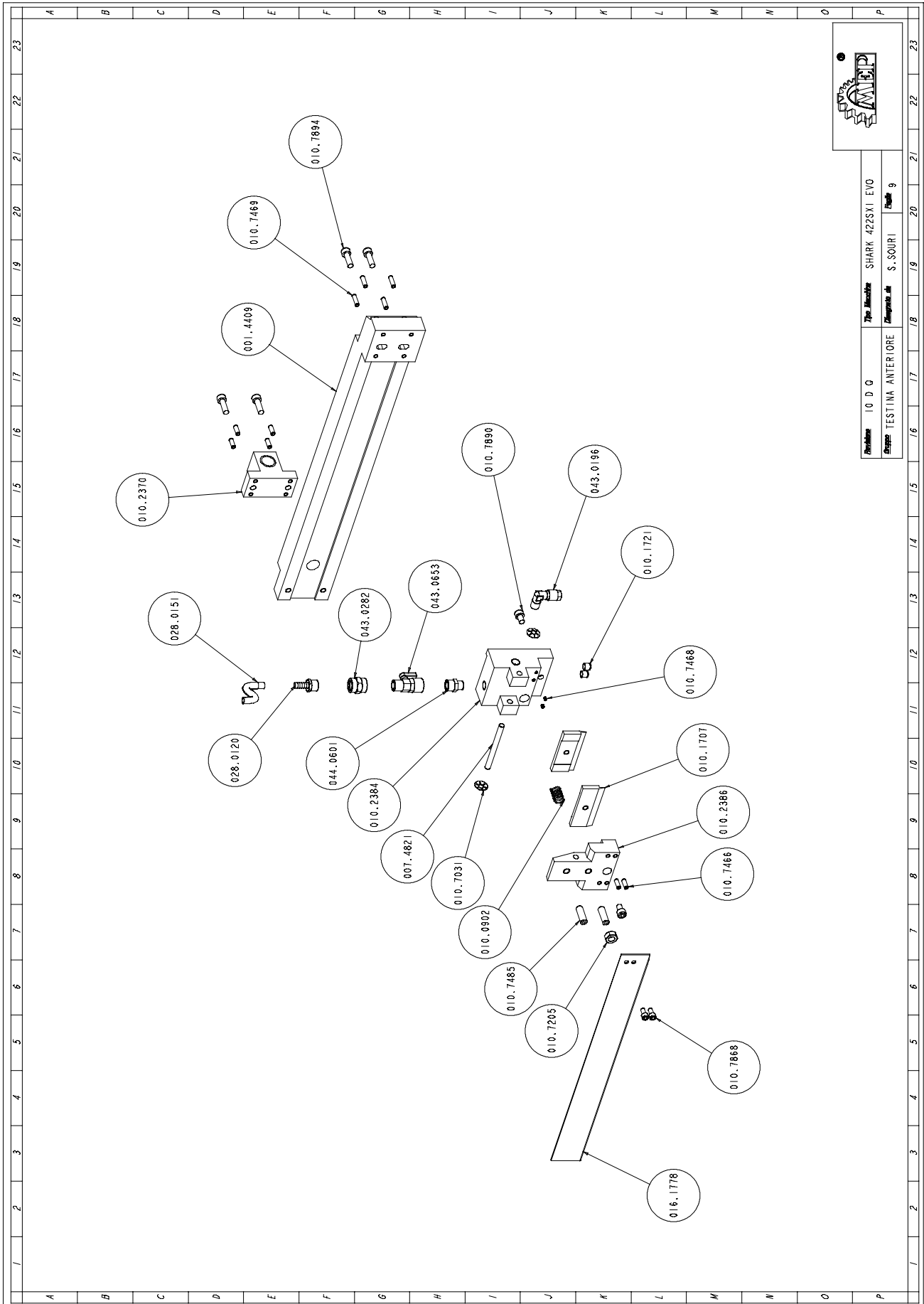

		Modello	SHARK 422 SXI EVO
		Gruppo	TESTINA ANTERIORE
		Figura	9
		Revisione	0

<b>Art. NR.</b>	<b>Benaming</b>	<b>M.</b>	<b>Hoeveelheid</b>
001.4409	STAFFA-SUPP-TESTINA-ANT-SH400.PRT	NR	1
007.4821	PERNO-SNODO-TESTINA-SH400.PRT	NR	1
010.0902	MOLLA-PFISSO.PRT	NR	1
010.1707	GUIDALAMA-SH400.PRT	NR	2
010.1721	BOTTONE.PRT	NR	2
010.2370	CHIOC-SLITTA-TEST-GUID-SH400.PRT	NR	1
010.2384	TESTINA-GUID-ANT-FISSA-SH400.PRT	NR	1
010.2386	TETSINA-GUID-ANT-MOBILE-SH400.PRT	NR	1
010.7031	ANELLO-SEEGER-SK8.PRT	NR	2
010.7205	DADO-M10.PRT	NR	1
010.7466	M6X16-VCEI-P.PRT	NR	6
010.7468	M4X4-VCEI-P.PRT	NR	2
010.7469	M6X20-VCEI-P.PRT	NR	4
010.7485	M10X30-VCEI-P.PRT	NR	2
010.7868	M6X12-TCEI.PRT	NR	2
010.7890	M8X12-TCEI.PRT	NR	2
010.7894	M8X25-TCEI.PRT	NR	4
016.1778	PROT-LAMA-ANT-SH400-NT.PRT	NR	1
028.0120	RACCORDO-3_8-9_CL2601.PRT	NR	1
028.0151	TUBO-PLASTIFICATO-07-11.PRT	NR	1
043.0196	RACCORDO-GOMITO-MF8X1_4CL1020.PRT	NR	1
043.0282	MANICOTTO-3_8.PRT	NR	1
043.0653	RUBINETTO-MF-3_8-CL6310.PRT	NR	1
044.0601	RIDUZIONE-MMRC-3_8-1_4.PRT	NR	1



<b>Art. NR.</b>	<b>Benaming</b>	<b>M.</b>	<b>Hoeveelheid</b>
007.2505	PROLUNGA-FORCELLA.PRT	NR	1
007.5373	PROLUNGA-TEST-ANT-CIL-SH420SXI.ASM	NR	1
010.1103	FORCELLA-16X1.PRT	NR	1
010.7603	ROSETTA-6_4X12_5.PRT	NR	2
010.7895	M8X30-TCEI.PRT	NR	4
010.8942	M6X12-TE.PRT	NR	2
022.0046	POTENZIOMETRO-6693S001-202-SHSX.PRT	NR	1
022.0211	RACCORDO RAPIDO SEM PG 13,5	NR	1
022.0244	CONTRODADO 3217B GRIGIO PG 13,5	NR	1
025.0876	GIUNTO-W-A-6-6MM28.PRT	NR	1
043.0250	GOMITO M.F. 1/4 CL 2020	NR	1
043.0340	RONDELLA-RAME-1_4.PRT	NR	2
043.5671	PROTEZIONE-POT-CILINDRO.PRT	NR	1
044.0501	NIPPLO-NP-1_4-IDRAULICO.PRT	NR	1
044.0505	NIPPLO E.19X29X1/4 G.ZINC.G.	NR	1
044.1005	CILINDRO-IDRUL63-150MMSH280-320.ASM	NR	1

### Hydraulische aggregaten

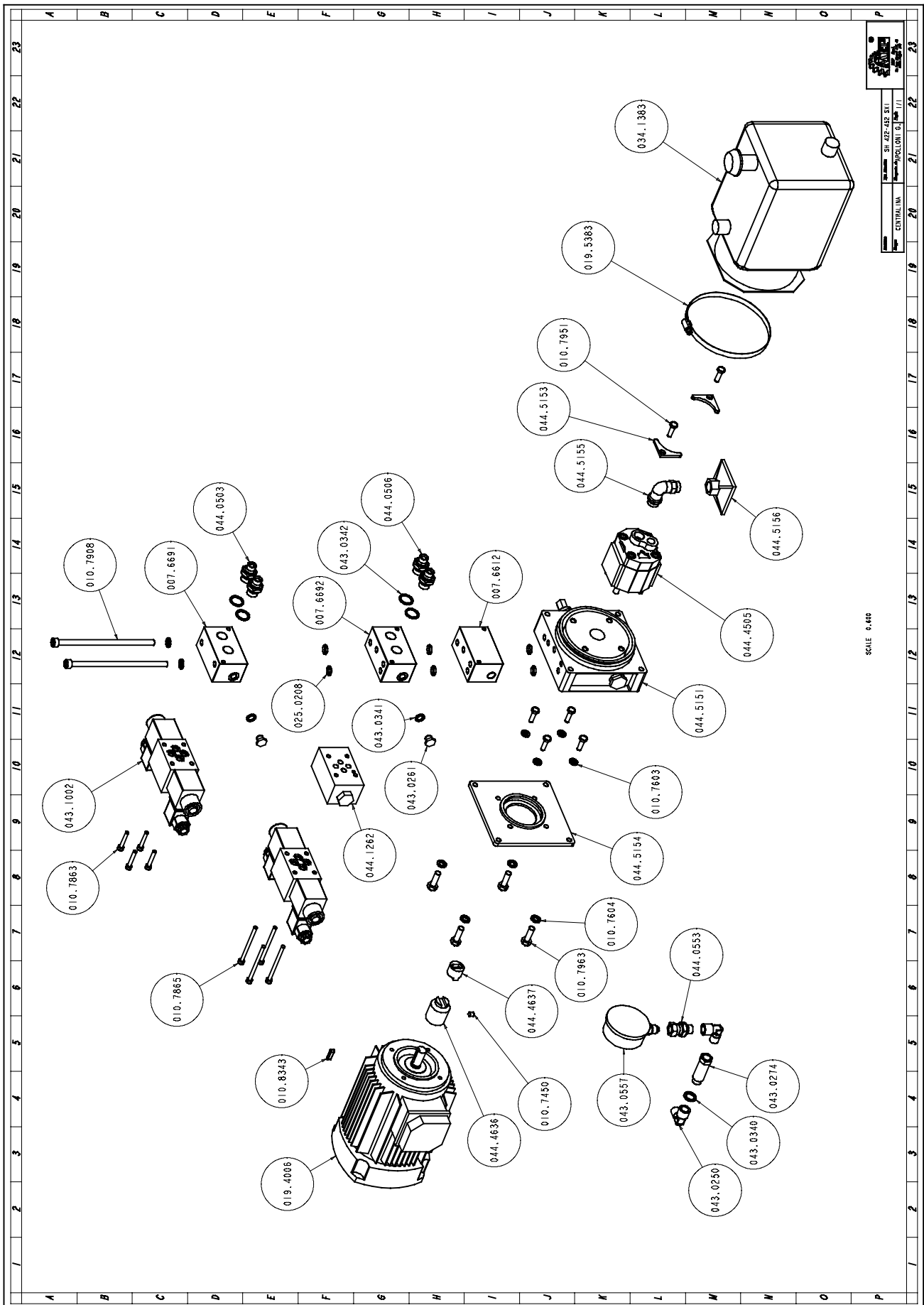

<b>Art. NR.</b>	<b>Benaming</b>	<b>M.</b>	<b>Hoeveelheid</b>
044.0012	MONOCENTRALINA IDRAULICA CTRG15	NR	1,000
007.6612	DIST-PANNELLO-IDRAULICO.PRT	NR	1
007.6691	PANNELLO-IDR-TERMINALE.PRT	NR	1
007.6692	PANNELLO-IDR-CENTRALE.PRT	NR	1
010.7603	ROSETTA-6_4X12_5.PRT	NR	4
010.7604	ROSETTA-8_4X14.PRT	NR	6
010.7908	M8X160-TCEI.PRT	NR	2
010.7908	M8X50-TCEI.PRT	NR	4
019.4006	MOTORE-CENTRALINA-HP05C71B14.PRT	NR	1
043.0250	GOMITO-MF1_4CL2020.PRT	NR	2
043.0340	RONDELLA-RAME-1_4.PRT	NR	7
043.0557	MANOMETRO-0-60-WIKA.PRT	NR	1
043.1002	ELETTRIVALVOLA MD 1L-S1/10N-D24K1 CON BOBINA X CENTRALINA SXI-EVO	NR	1
010.7865	VITE TCEI 5 X 70	NR	1
010.8343	CHIAVETTA 5 X 5 X 20	NR	1
010.7603	RONDELLA 0 6	NR	1
010.7604	RONDELLA 0 8	NR	1
010.7450	GRANO VCE PUNTA CONICA 6 X 6	NR	1
010.7951	VITE TE 6 X 20	NR	1
025.0208	ANELLO TENUTA OR 109-9,13	NR	1
043.0342	RONDELLA RAME 3/8	NR	1
043.0341	RONDELLA RAME 10X5	NR	1
043.0261	TAPPO TTE8 1/8 - CL 2611	NR	1
010.7863	VITE TCEI 5 X 30	NR	1
044.4505	POMPA IDRAULICA MONOCENTRALINA CC 1,7 XSXI-EVO	NR	1
010.7963	VITE TE 8 X 25	NR	1
043.0274	RACCORDO MF 1/4-43 CL 2525 SH 330	NR	1
044.0506	NIPPLO E.22X32,5 ZINC.G.	NR	1
044.0503	NIPPLO IDRAULICO M 3/8-M 1/4	NR	1
044.1262	VALVOLA MODULARE DI BLOCCO SH SXI / NCEVO (MVPP-D/50)	NR	1
044.0553	RACCORDO IDRAULICO MF 1/4 GIREVOLE X MANOMETRO CENTRALINA	NR	1
044.5151	COLLETTORE PER POMPA DA 1,7 SXI-EVO	NR	1
044.4637	GIUNTO COLLEGAMENTO LATO POMPA X MONOCENTRALINA SH NC-EVO	NR	1
044.4636	GIUNTO COLLEGAMENTO LATO MOTORE X MONOCENTRALINA SH NC-EVO	NR	1
019.5383	FASCETTA MINUS GT 130 X MONOCENTRALINA SXI-EVO	NR	1
034.1383	SERBATOIO MOTORE X MONOCENTRALINA	NR	1
044.5153	STAFFA SERBATOIO X MONOCENTRALINA	NR	1
044.5155	ASTA PESCANTE X MONOCENTRALINA SXI-EVO	NR	1
044.5156	FILTRO ASPIRAZ X MONOCENTRALINA SXI-EVO	NR	1
044.5154	FLANGIA MOTORE X MONOCENTRALINA SXI-EVO	NR	1



Rollenbanen

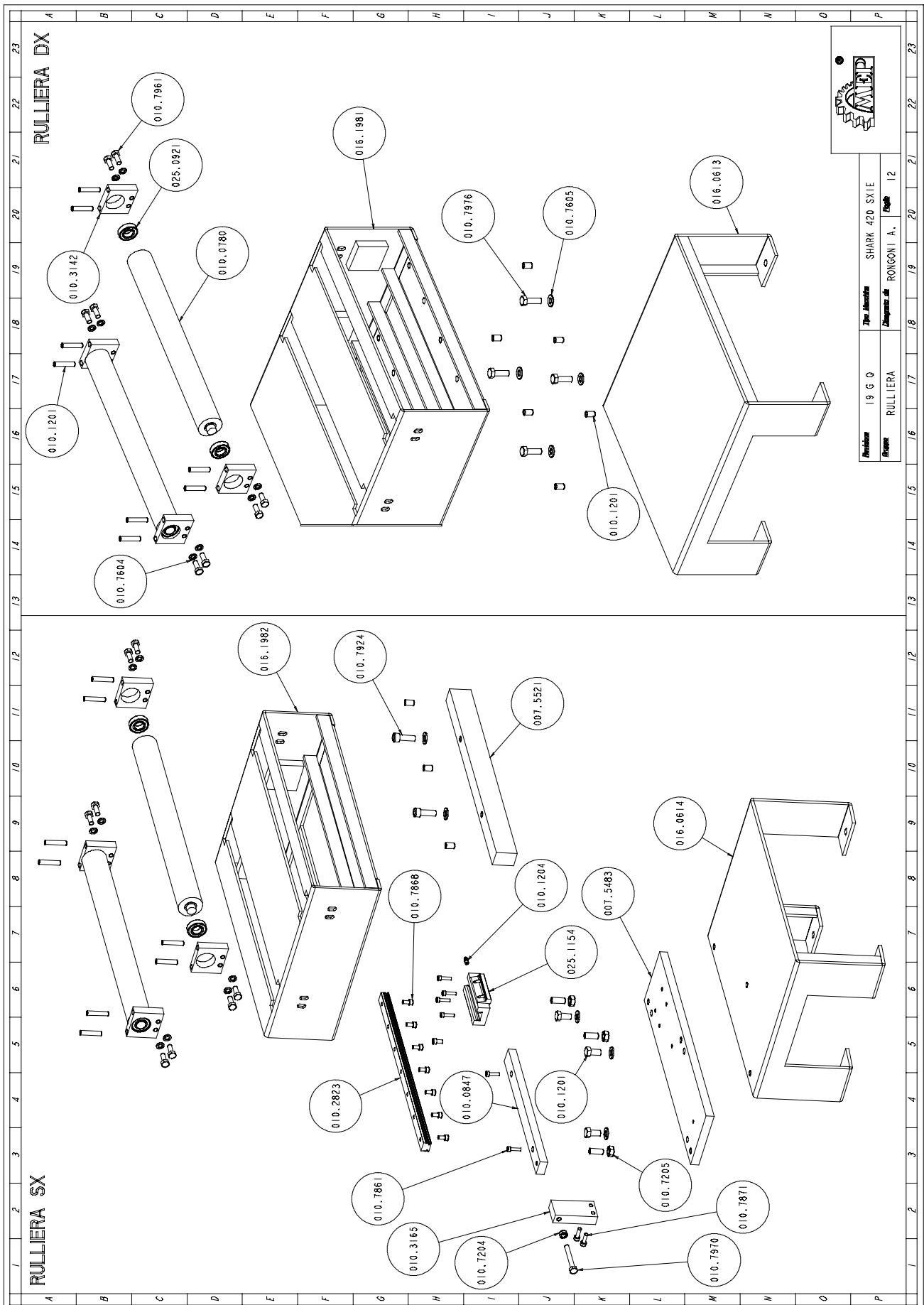

<b>Art. NR.</b>	<b>Benaming</b>	<b>M.</b>	<b>Hoeveelheid</b>
007.5483	PIASTRA FISSAGGIO RULLIERA SINISTRA	NR	1,000
007.5521	APPOGGIO REGOLABILE PER RULLIERA	NR	1,000
010.0780	RULLO 0 45 X RULLIERA SH 420 SXI	NR	1,000
010.0847	SUPPORTO GUIDA PATTINO DX-SX SH 420	NR	1,000
010.1201	VITERIA E BULLONERIA	NR	17,000
010.1204	INGRASSATORE M 6	NR	1,000
010.2823	GUIDA PATTINO HGR20 - R0400	NR	1,000
010.3142	SUPPORTO X RULLO 0 45 RULLIERA SH	NR	2,000
010.3165	BATTUTA X RULLIERA DX-SX SH 420 SE	NR	1,000
010.7204	DADO M8	NR	1,000
010.7205	DADO M10	NR	3,000
010.7604	RONDELLA DIAM. 8	NR	8,000
010.7605	RONDELLA DIAM. 10	NR	5,000
010.7861	VITE TCEI 5 X 20	NR	6,000
010.7868	VITE TCEI 6 X 12	NR	7,000
010.7871	VITE TCEI 6 X 20	NR	2,000
010.7924	VITE TCEI 10 X 30	NR	2,000
010.7961	VITE TE 8 X 20	NR	8,000
010.7970	VITE TE 8 X 60	NR	1,000
016.0614	SUPPORTO X RULLIERA SX SH 420 SE	NR	1,000
016.1982	CORPO RULLIERA SINISTRA SH 420 SXI	NR	1,000
025.0921	CUSCINETTO 6003 2Z	NR	2,000
025.1154	PATTINO HGW20 HCZ 0C	NR	1,000
090.2504	RULLIERA APPOGGIA BARRA SINISTRA	NR	1,000

<b>Art. NR.</b>	<b>Benaming</b>	<b>M.</b>	<b>Hoeveelheid</b>
010.1201	VITERIA E BULLONERIA	NR	14,000
010.7604	RONDELLA DIAM. 8	NR	8,000
010.7605	RONDELLA DIAM. 10	NR	4,000
010.7961	VITE TE 8 X 20	NR	8,000
010.7976	VITE TE 10 X 30	NR	4,000
016.0613	SUPPORTO X RULLIERA DESTRA SH 420SE	NR	1,000
016.1981	CORPO RULLIERA DESTRA SH 420 SXI	NR	1,000
090.2503	RULLIERA APPOGGIA BARRA DESTRA	NR	1,000

## Bedieningspaneel groep

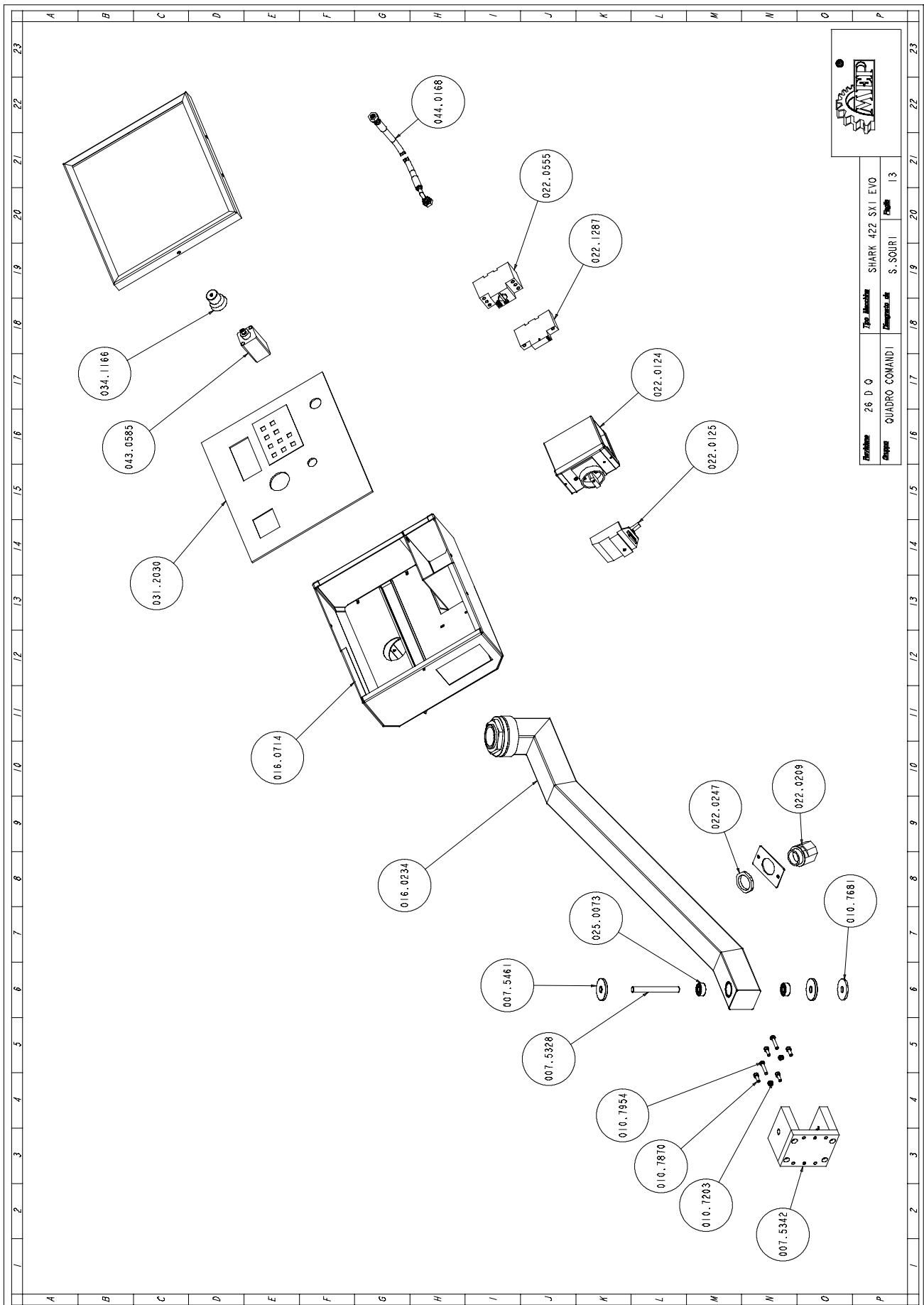

<b>Art. NR.</b>	<b>Benaming</b>	<b>M.</b>	<b>Hoeveelheid</b>
007.5328	PERNO-CUSC-ASTA-MOB-SH420.PRT	NR	1
007.5342	SUPPORTO-ASTA-MOBILE-SH420.ASM	NR	1
007.5461	ROSETTA-ASTA-MOBILE-SH420.PRT	NR	2
010.7203	DADO-M6.PRT	NR	2
010.7681	ROSETTA-13X48.PRT	NR	1
010.7870	M6X16-TCEL.PRT	NR	4
010.7954	M6X30-TE.PRT	NR	2
016.0234	ASTA-MOB-CONS-CON-GIUNTO-452.ASM	NR	1
016.0714	QUADRO-COMANDI-SH-SXI-NT.ASM	NR	1
022.0124	INTERRUTTORE-PKZ0-GR.ASM	NR	1
022.0125	BLOCCO-LUCCHETTO-SVB-PKZ0.ASM	NR	1
022.0209	PG-29-KIEPE.PRT	NR	1
022.0247	DADO-POLIAM-HUMMEL-262-2900-11.PRT	NR	1
022.0555	SGANCIATORE-U-PKZ0-V400.PRT	NR	1
022.1287	INTERRUTTORE-PKZM0-TERMICA.PRT	NR	1
025.0073	63001.PRT	NR	2
031.2030	QUACOM-SH-SXI-MOSTRINA.PRT	NR	1
034.1169	MANOPOLA-REG-MONOG.PRT	NR	1
043.0594	REGOLATORE-IDRA-MONOG.PRT	NR	1
044.0168	TUBO-IDR-MM7800-DG.PRT	NR	1