

Explosietekeningen

In het nu volgende deel zijn de explosietekeningen van de machine opgenomen. De tekeningen met hun volledige details kunnen helpen de machine beter te leren kennen.

Hoofd eenheid 4 snelheden

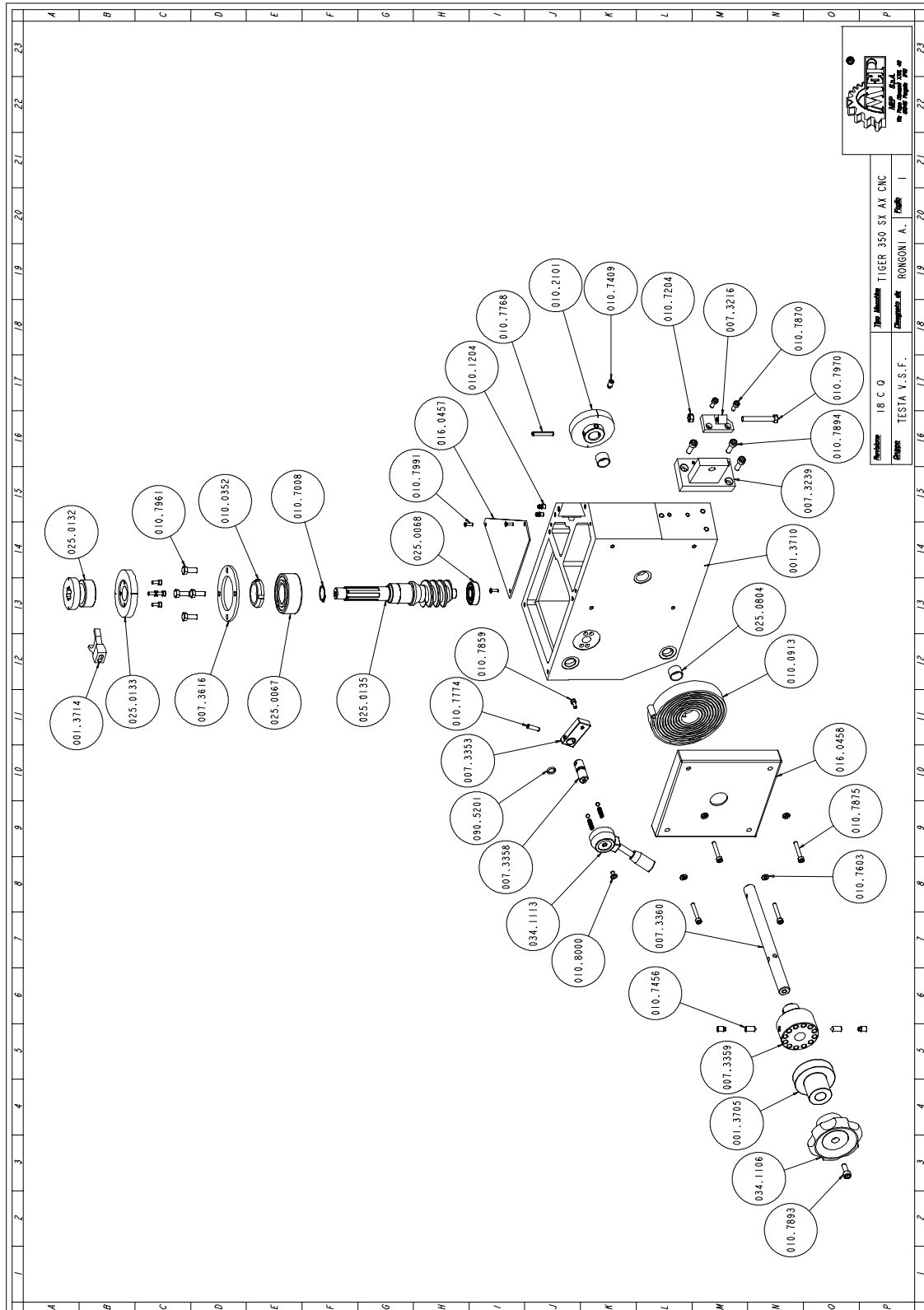

Art. Nr.	Benaming	M.	Hoeveelheid
001.3705	SUPPORTO VOLANTINO	NR	1,000
001.3714	FORCELLA CAMBIO	NR	1,000
007.3216	BATTUTA FINECORSIA	NR	1,000
007.3239	PIASTRA ATTACCO ASTA CILINDRO	NR	1,000
007.3353	PIASTRINO COMANDO CAMBIO	NR	1,000
007.3358	PERNO LEVA CAMBIO	NR	1,000
007.3359	BOCCOLA RIPRESA CORSA	NR	1,000
007.3360	ALBERO MOVIMENTO TESTA	NR	1,000
007.3616	GHIERA FIX CUSCINETTO	NR	1,000
010.0352	GHIERA AUTOBLOCCANTE 35X1,5	NR	1,000
010.0913	MOLLA SOLLEVAMENTO TESTA	NR	1,000
010.1204	INGRASSATORE M 6	NR	2,000
010.2101	RUOTA SOLLEVAMENTO TESTA	NR	1,000
010.7008	ANELLO SEEGER DIAM. 25	NR	1,000
010.7204	DADO M8	NR	1,000
010.7409	GRANO VCE P.CIL. 8 X 10	NR	3,000
010.7456	GRANO VCE P.CON. 8 X 16	NR	2,000
010.7603	RONDELLA DIAM. 6	NR	4,000
010.7768	SPINA ELASTICA DIAM. 6 X 40	NR	1,000
010.7774	SPINA ELASTICA DIAM. 6 X 26	NR	1,000
010.7859	VITE TCEI 5 X 12	NR	5,000
010.7870	VITE TCEI 6 X 16	NR	2,000
010.7875	VITE TCEI 6 X 40	NR	4,000
010.7893	VITE TCEI 8 X 20	NR	1,000
010.7894	VITE TCEI 8 X 25	NR	3,000
010.7961	VITE TE 8 X 20	NR	4,000
010.7970	VITE TE 8 X 60	NR	1,000
010.7991	VITE TSPEI 4 X 12	NR	3,000
010.8000	VITE TSPEI 6 X 8	NR	1,000
016.0457	COPERCHIO TESTA	NR	1,000
016.0458	COPERCHIO MOLLA	NR	1,000
025.0067	CUSCINETTO 3207	NR	1,000
025.0068	CUSCINETTO 6203	NR	1,000
025.0132	RUOTA DENTATA 43007/53 ALBERO VSF	NR	1,000
025.0133	RUOTA DENTATA 43005/53 ALBERO VSF	NR	1,000
025.0135	ALBERO VITE SENZA FINE 43003/53	NR	1,000
025.0804	BOCCOLA GRAFITATA L. 15 DIAM. 20	NR	2,000
034.1106	VOLANTINO DIAM.100 A 6 LOBI	NR	1,000
034.1113	VOLANTINO DI MANOVRA	NR	1,000
090.5201	PARTICOLARI	NR	1,000

Kussengroep zaagbeugel 4 snelheden

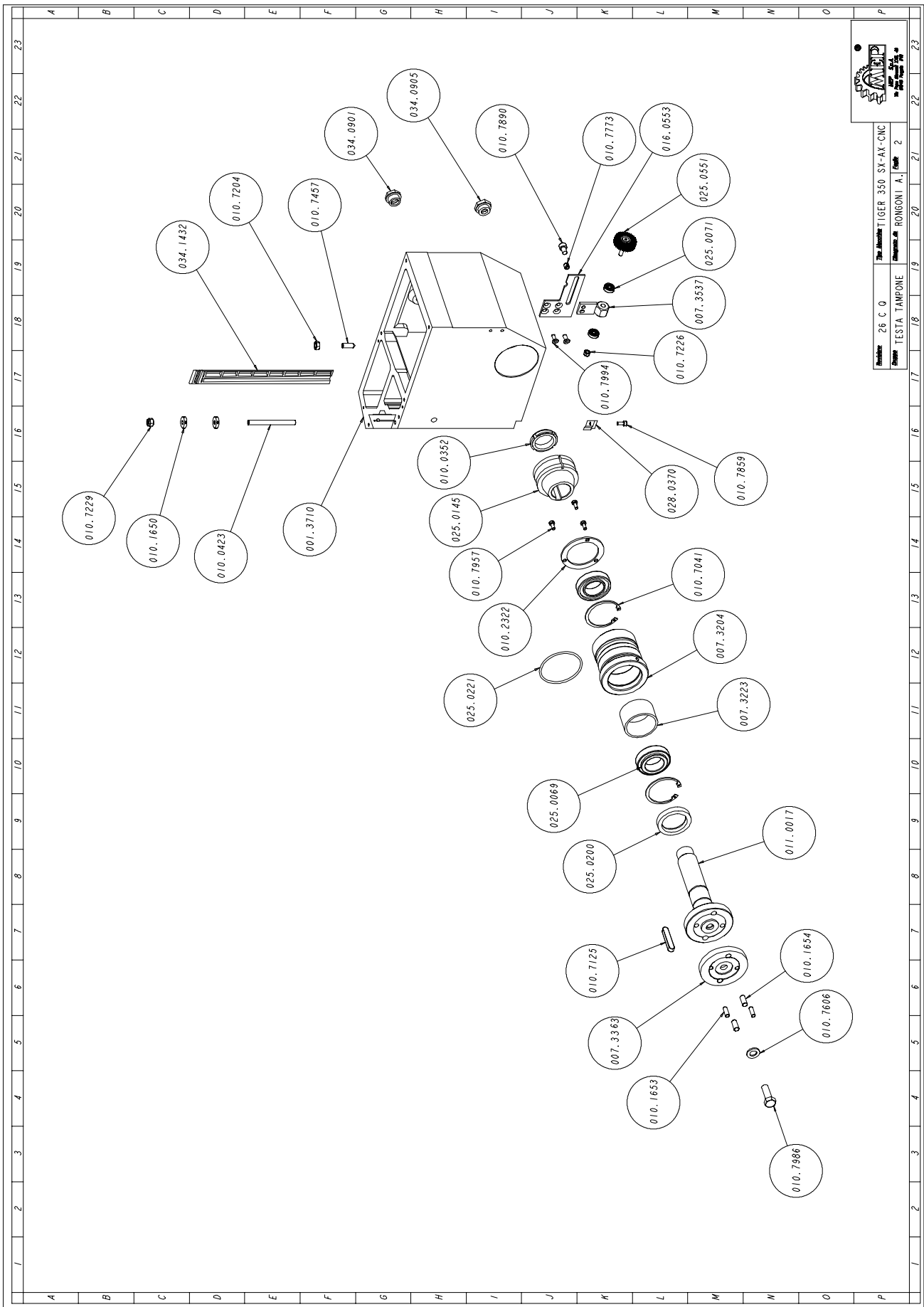

Art. Nr.	Benaming	M.	Hoeveelheid
001.3710	TESTA OPERATRICE	NR	1,000
007.3204	TAMPONE CUSCINETTI	NR	1,000
007.3363	FLANGIA ESTERNA	NR	1,000
007.3223	ANELLO DISTANZIALE CUSCINETTO	NR	1,000
007.3537	PIASTRINO PULILAMA COMPLETO	NR	1,000
010.0352	GHIERA AUTOBLOCCANTE 35X1,5	NR	1,000
010.0423	GRANO PUNTA PIANA 8X90	NR	1,000
010.1650	RONDELLA DI REGOLAZIONE LARDONE	NR	2,000
010.1653	PERNO FLANGIA	NR	2,000
010.1654	PERNO FLANGIA	NR	2,000
010.2322	FLANGIA BLOCCAGGIO CUSCINETTI	NR	1,000
010.7041	ANELLO SEEGER PER FORI DIAM. 65	NR	2,000
010.7125	CHIAVETTA 10 X 8 X 56	NR	1,000
010.7204	DADO M8	NR	1,000
010.7226	DADO AUTOBLOCCANTE M6	NR	1,000
010.7229	DADO AUTOBLOCCANTE M8	NR	1,000
010.7457	GRANO VCE P.CON. 8 X 20	NR	1,000
010.7606	RONDELLA DIAM. 12	NR	1,000
010.7773	SPINA ELASTICA DIAM. 8 X 10	NR	1,000
010.7859	VITE TCEI 5 X 12	NR	1,000
010.7890	VITE TCEI 8 X 12	NR	1,000
010.7957	VITE TE 5 X 12	NR	3,000
010.7986	VITE TE 12 X 35	NR	1,000
010.7994	VITE TSPEI 6 X 12	NR	2,000
011.0017	ALBERO PORTADISCO	NR	1,000
016.0553	GUIDA SPAZZOLA PULILAMA	NR	1,000
025.0069	CUSCINETTO 32007X	NR	2,000
025.0071	CUSCINETTO 626 2RS	NR	2,000
025.0145	CORONA ELICOIDALE DIS. 86.06.002	NR	1,000
025.0200	ANELLO TENUTA 62X45X10	NR	1,000
025.0221	ANELLO TENUTA OR 176-73,03	NR	1,000
025.0551	SPAZZOLA PULILAMA 6X25 030 GG43	NR	1,000
028.0370	BARRETTA VULCANIZZATA TIPO VAJ A1	MT	0,036
034.0901	"TAPPO LIVELLO OLIO 1/2 ""GAS."	NR	1,000
034.0905	"TAPPO OLIO TAO/3 1/2"" NERO"	NR	1,000
034.1432	GUIDA PRISMATICA	NR	1,000

Zaagmotor 4 snelheden

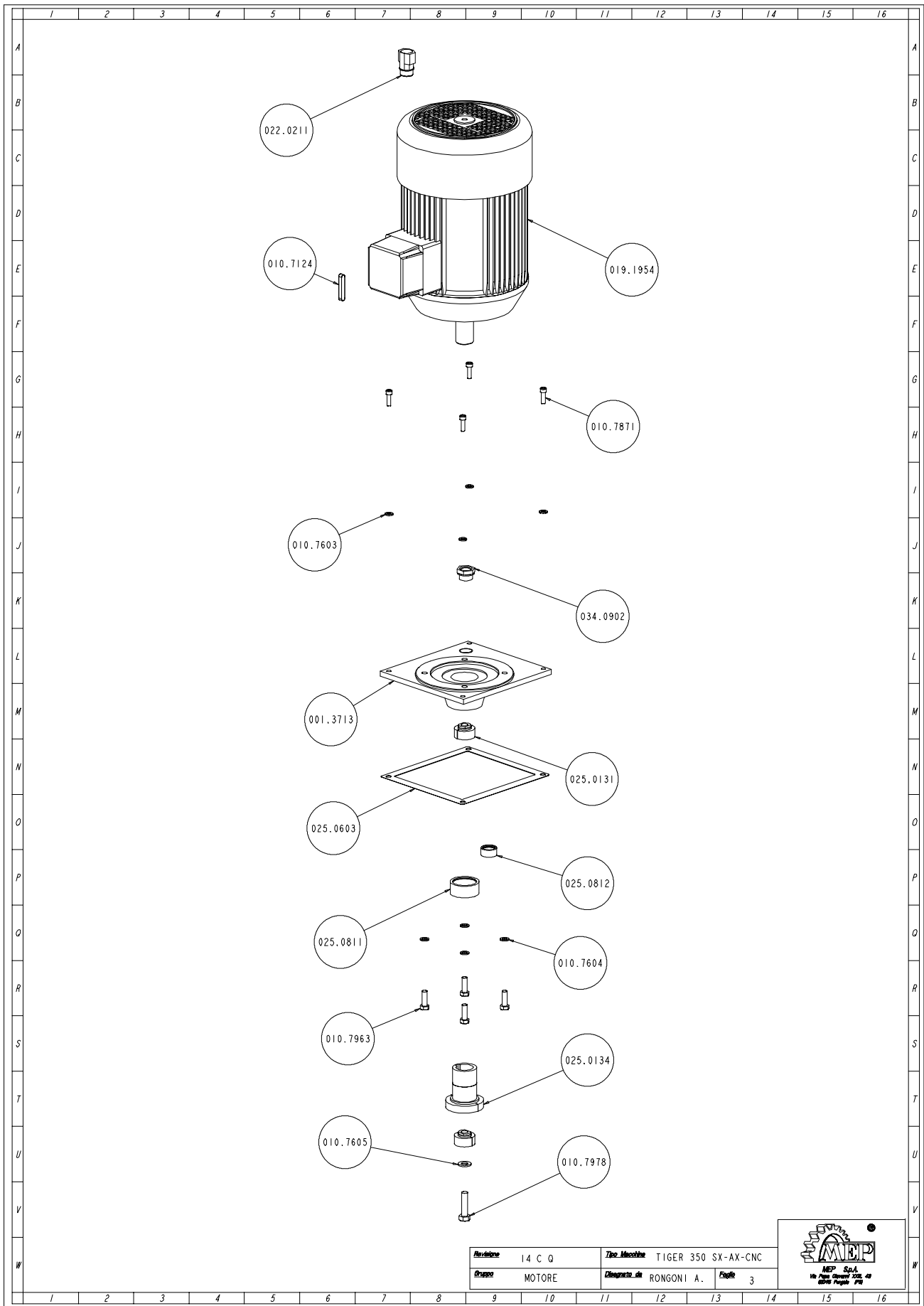

Revisione	I 4 C 0	Tip. Macchine	TIGER 350 SX-AX-CNC
Gruppo	MOTORE	Disegnato da	RONGONI A. Pag. 3



Art. Nr.	Benaming	M.	Hoeveelheid
001.3713	COPERCHIO SUPERIORE TESTA	NR	1,000
010.7124	CHIAVETTA 8 X 7 X 45	NR	1,000
010.7603	RONDELLA DIAM. 6	NR	4,000
010.7604	RONDELLA DIAM. 8	NR	4,000
010.7605	RONDELLA DIAM. 10	NR	1,000
010.7871	VITE TCEI 6 X 20	NR	4,000
010.7963	VITE TE 8 X 25	NR	4,000
010.7978	VITE TE 10 X 40	NR	1,000
019.1954	KW 2,6/1,84 8/4P.C112 B.14 V.380	NR	1,000
022.0211	RACCORDO RAPIDO SEM PG 13,5	NR	1,000
025.0131	RUOTA DENTATA 43004/53 ALB. MOT.4V.	NR	1,000
025.0134	RUOTA DENTATA 43006/53 ALB.MOTORE4V	NR	1,000
025.0603	GUARNIZIONE TESTA 4 VEL.	NR	1,000
025.0811	BOCCOLA A RULLINI DHK 4020 HK	NR	1,000
025.0812	BOCCOLA A RULLINI DHK 2012 HK	NR	1,000
034.0902	"TAPPO OLIO SFP 1/2" ROSSO"	NR	1,000

Klem

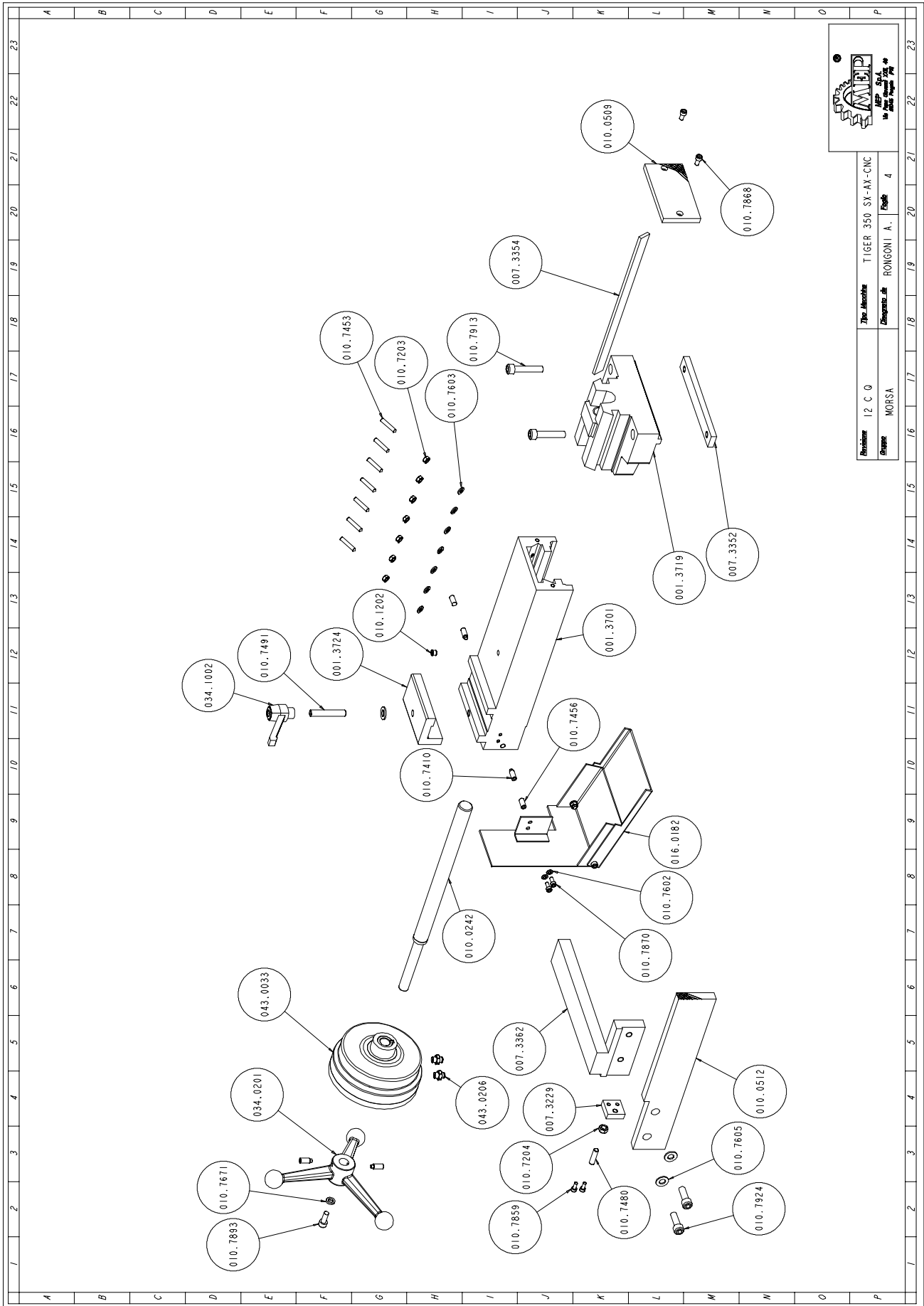

Revisione	12 C 0	Titolo/Macchine	TIGER 350 SX-AX-CNC
Disegnato	MORSA	Disegnato da	RONGONI A.
		Scala	4

Art. Nr.	Benaming	M.	Hoeveelheid
001.3701	SCORREVOLE MORSA	NR	1,000
001.3719	CHIOCCIOLA VITE MORSA	NR	1,000
001.3724	STAFFA REGOLAZIONE ANTIBAVA	NR	1,000
007.3229	TASSELLO X BATTUTA SCORR. ANTIBAVA	NR	1,000
007.3352	PIASTRINO BLOCCAGGIO CHIOCCIOLA	NR	1,000
007.3354	LARDONE MORSA	NR	1,000
007.3362	ASTA SCORREVOLE ANTIBAVA	NR	1,000
010.0242	VITE MORSA	NR	1,000
010.0509	GANASCIA MORSA	NR	1,000
010.0512	GANASCIA ANTIBAVA	NR	1,000
010.1202	OLIATORE A SFERA DIAM. 8	NR	1,000
010.7203	DADO M6	NR	7,000
010.7204	DADO M8	NR	1,000
010.7410	GRANO VCE P.CIL. 8 X 16	NR	4,000
010.7453	GRANO VCE P.CON. 6 X 30	NR	7,000
010.7456	GRANO VCE P.CON. 8 X 16	NR	2,000
010.7480	GRANO VCE PUNTA PIANA 8 X 30	NR	1,000
010.7491	GRANO VCE PUNTA PIANA 10 X 60	NR	1,000
010.7602	RONDELLA DIAM. 5	NR	2,000
010.7603	RONDELLA DIAM. 6	NR	9,000
010.7605	RONDELLA DIAM. 10	NR	3,000
010.7671	RONDELLA SPESSORE DIAM. 8 X 3	NR	1,000
010.7859	VITE TCEI 5 X 12	NR	4,000
010.7868	VITE TCEI 6 X 12	NR	2,000
010.7870	VITE TCEI 6 X 16	NR	2,000
010.7893	VITE TCEI 8 X 20	NR	1,000
010.7913	VITE TCEI 10 X 50	NR	2,000
010.7924	VITE TCEI 10 X 30	NR	2,000
016.0182	RACCOGLITORE ACQUA MORSA	NR	2,000
034.0201	VOLANTINO MORSA GRANDE	NR	1,000
034.1002	LEVA A SCATTO 10 MA	NR	1,000
043.0033	CILINDRO VOLAMPRESS 125-8	NR	1,000
043.0206	ATTACCO A ESAGONO 4X1/8 - CL 6511	NR	2,000

Draaitafel

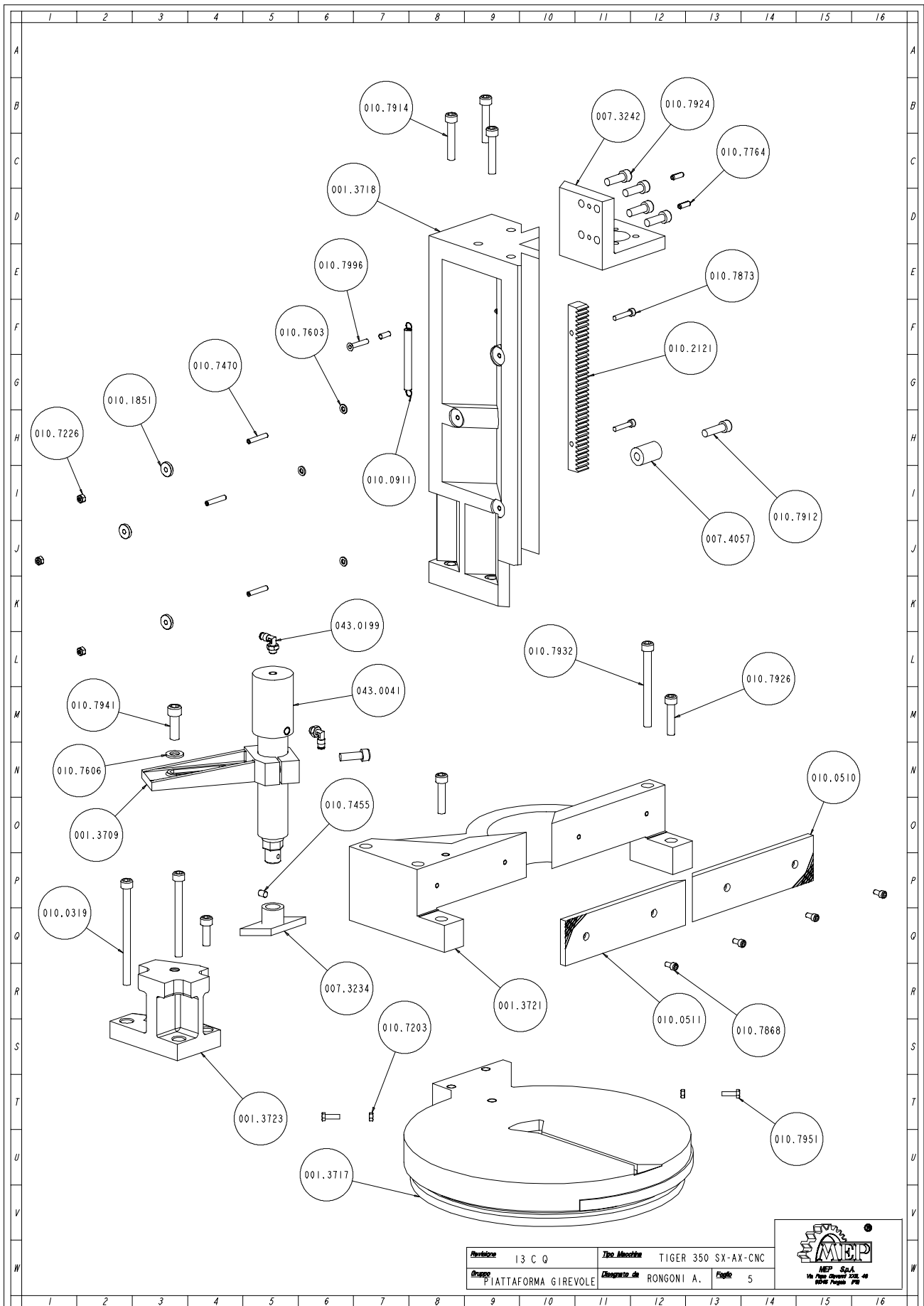

Art. Nr.	Benaming	M.	Hoeveelheid
001.3709	STAFFA BLOCCAGGIO CILINDRO SUPPLEM.	NR	1,000
001.3717	PIATTAFORMA GIREVOLE	NR	1,000
001.3718	COLONNA PORTANTE	NR	1,000
001.3721	SQUADRO MORSA	NR	1,000
001.3723	SUPPORTO CILINDRO SUPPLEMENTARE	NR	1,000
007.3234	BOCCOLA/GANASCIA X CILIN.SUPPLEMEN.	NR	1,000
007.3242	SUPPORTO CILINDRO	NR	1,000
007.4057	BOCCOLA BATTUTA FINE CORSA	NR	1,000
010.0319	VITE 8.8 TCEI 10X140 TI	NR	1,000
010.0510	GANASCIA MORSA DESTRA	NR	1,000
010.0511	GANASCIA MORSA SINISTRA	NR	1,000
010.0911	MOLLA RICHIAMO CARTER DISCO	NR	1,000
010.1851	BOCCOLA PER CARTER DISCO -DIAM 20	NR	3,000
010.2121	CREMAGLIERA	NR	1,000
010.7203	DADO M6	NR	2,000
010.7226	DADO AUTOBLOCCANTE M6	NR	3,000
010.7455	GRANO VCE P.CON. 8 X 10	NR	1,000
010.7470	GRANO VCE PUNTA PIANA 6 X 35	NR	3,000
010.7603	RONDELLA DIAM. 6	NR	3,000
010.7606	RONDELLA DIAM. 12	NR	1,000
010.7764	SPINA ELASTICA DIAM. 6 X 20	NR	2,000
010.7868	VITE TCEI 6 X 12	NR	4,000
010.7873	VITE TCEI 6 X 30	NR	2,000
010.7912	VITE TCEI 10 X 35	NR	1,000
010.7914	VITE TCEI 10 X 55	NR	3,000
010.7924	VITE TCEI 10 X 30	NR	6,000
010.7926	VITE TCEI 10 X 45	NR	2,000
010.7932	VITE TCEI 10 X 110	NR	2,000
010.7941	VITE TCEI 12 X 35	NR	1,000
010.7951	VITE TE 6 X 20	NR	2,000
010.7996	VITE TSPEI 6 X 30	NR	1,000
043.0041	CILINDRO MORSE 50X10 0 40 L.150 D.E	NR	1,000
043.0199	ATTACCO A GOMITO GIREV.4X1/8 CL6521	NR	2,000

Vaste tafel

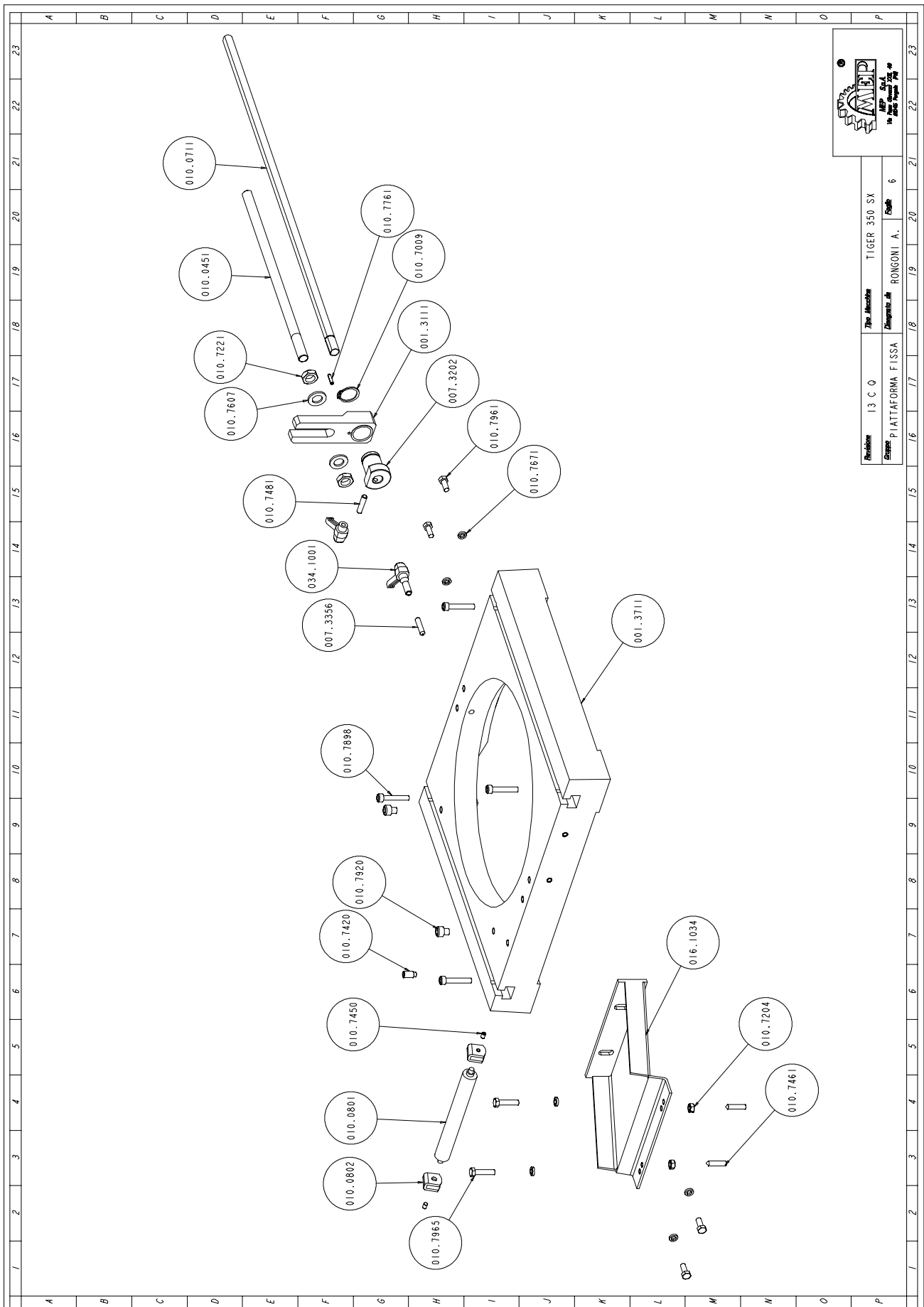

Art. Nr.	Benaming	M.	Hoeveelheid
001.3111	DISTANZIALE BATTUTA	NR	1,000
001.3711	PIATTAFORMA FISSA	NR	1,000
007.3202	BOCCOLA X BATTUTA	NR	1,000
007.3356	PERNO BLOCCAGGIO PIANO GIREVOLE	NR	1,000
010.0451	TIRANTE BATTUTA TAGLI MISURA	NR	1,000
010.0711	ASTA MILLIM.CROMATA MM.600 FIL. M16	NR	1,000
010.0801	RULLO TIPO	NR	1,000
010.0802	SUPPORTO PER RULLO	NR	2,000
010.7009	ANELLO SEEGER DIAM. 30	NR	1,000
010.7204	DADO M8	NR	2,000
010.7221	DADO M16 BASSO	NR	2,000
010.7420	GRANO VCE P.CIL. 10 X 16	NR	1,000
010.7450	GRANO VCE P.CIL. 6 X 6	NR	2,000
010.7461	GRANO VCE PUNTA PIANA 6 X 25	NR	2,000
010.7481	GRANO VCE PUNTA PIANA 8 X 35	NR	1,000
010.7607	RONDELLA DIAM. 16	NR	2,000
010.7671	RONDELLA SPESSORE DIAM. 8 X 3	NR	6,000
010.7761	SPINA ELASTICA DIAM. 4 X 20	NR	1,000
010.7898	VITE TCEI 8 X 45	NR	4,000
010.7920	VITE TCEI 10 X 10	NR	2,000
010.7961	VITE TE 8 X 20	NR	4,000
010.7965	VITE TE 8 X 35	NR	2,000
016.1034	BRACCETTO APPOGGIA BARRA	NR	1,000
034.1001	LEVA A SCATTO 8 MA PK55	NR	2,000

Eenheid ter afdekking zaagblad

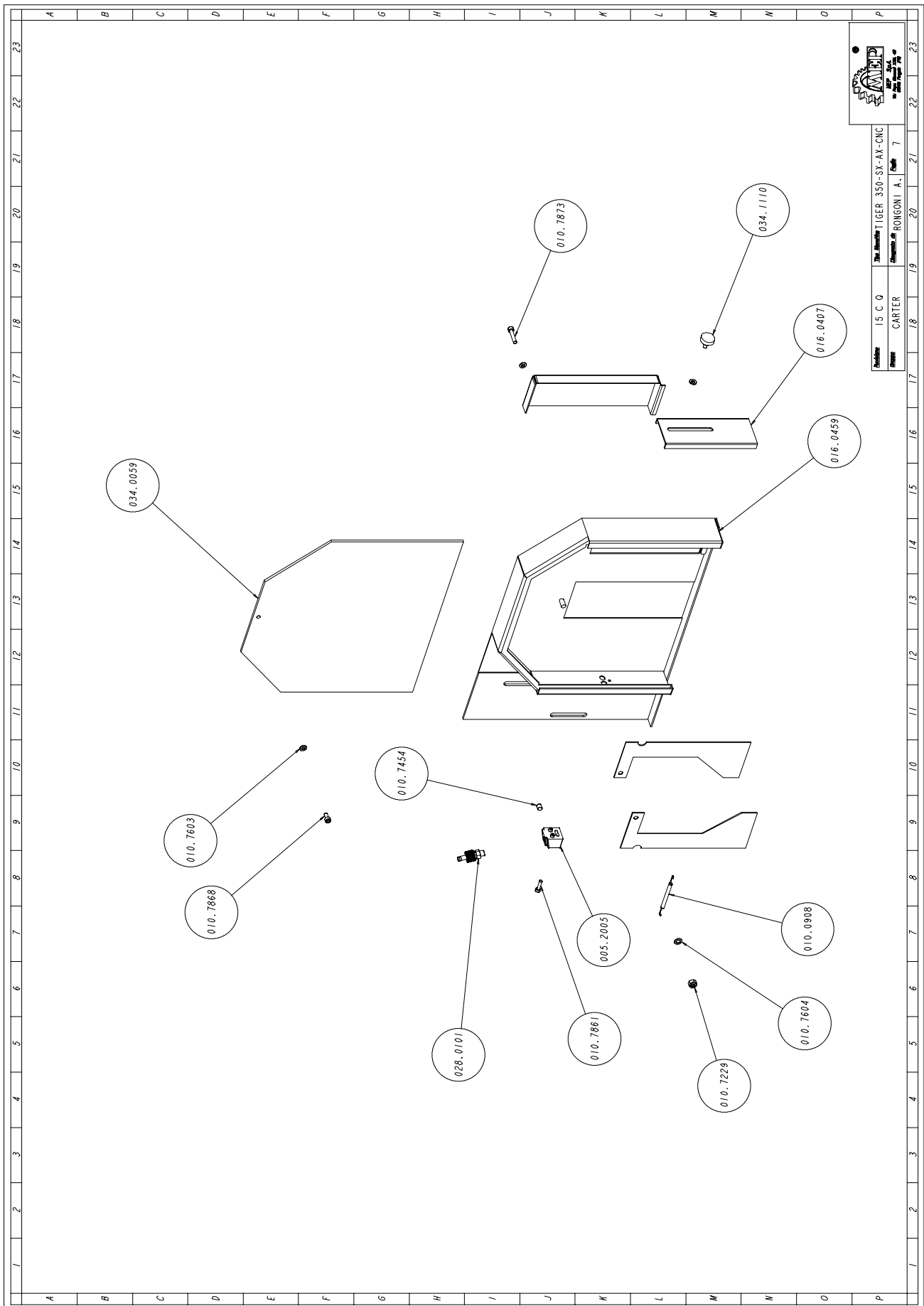

Art. Nr.	Benaming	M.	Hoeveelheid
005.2005	SPRUZZATORE RUBINETTO	NR	1,000
010.0908	MOLLA CARTER DISCO	NR	1,000
010.7229	DADO AUTOBLOCCANTE M8	NR	1,000
010.7454	GRANO VCE P.CON. 8 X 8	NR	1,000
010.7603	RONDELLA DIAM. 6	NR	3,000
010.7604	RONDELLA DIAM. 8	NR	1,000
010.7861	VITE TCEI 5 X 20	NR	1,000
010.7868	VITE TCEI 6 X 12	NR	1,000
010.7873	VITE TCEI 6 X 30	NR	1,000
016.0407	PARASCHIZZI ANTERIORE	NR	1,000
016.0459	CARTER DISCO	NR	1,000
028.0101	REGOLATORE PER RUBINETTO 8 X 1/4	NR	1,000
034.0059	PROTEZ.LEXAN TI 350 + AD.SCELTA L.	NR	1,000
034.1110	VOLANTINO DIAM.30 M6 X 10	NR	1,000

Onderstel

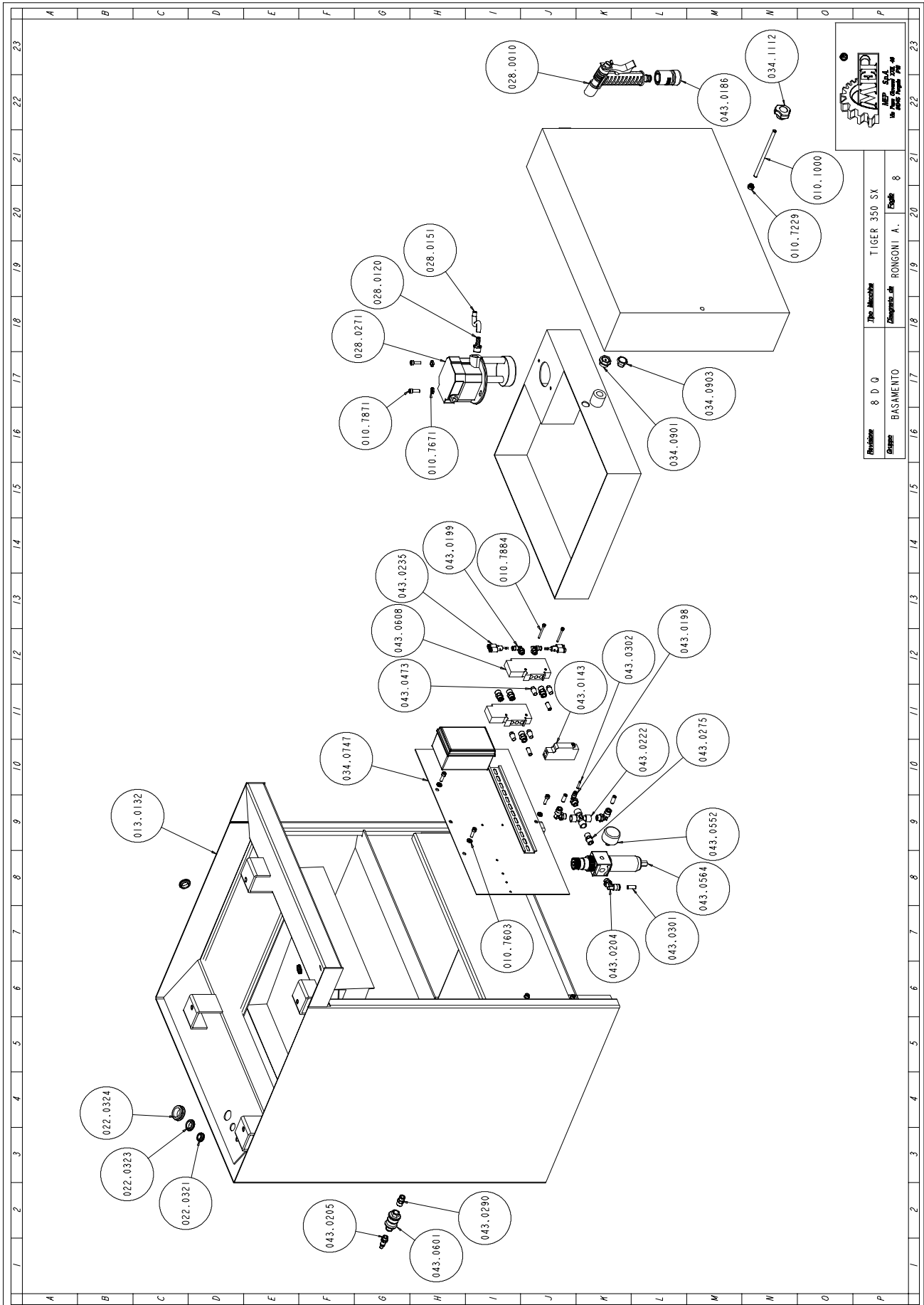

Art. Nr.	Benaming	M.	Hoeveelheid
010.1000	BARRA FILETTATA 8MA	MT	0,170
010.7229	DADO AUTOBLOCCANTE M8	NR	1,000
010.7603	RONDELLA DIAM. 6	NR	7,000
010.7671	RONDELLA SPESSORE DIAM. 8 X 3	NR	2,000
010.7871	VITE TCEI 6 X 20	NR	5,000
010.7884	VITE TCEI 4 X 40	NR	2,000
013.0132	PIEDISTALLO	NR	1,000
022.0321	PASSACAVI 12 INC.MM.2	NR	2,000
022.0323	PASSACAVI 18 INC.MM.2,5	NR	2,000
022.0324	PASSACAVI 24 INC.MM.2.5	NR	1,000
028.0010	PISTOLA	NR	1,000
028.0120	RACCORDO 3/8 - 9 CL 2601	NR	1,000
028.0151	TUBO PLASTIFICATO 07-11	MT	1,000
028.0271	ELETTROPOMPA EZ/C V. 220-380	NR	1,000
034.0747	QUADRO PNEUMATICO TI 350 SX	NR	1,000
034.0901	"TAPPO LIVELLO OLIO 1/2 ""GAS."	NR	1,000
034.0903	"TAPPI OLIO 3/8"" GAS"	NR	1,000
034.1112	VOLANTINO DIAM.40 M8	NR	1,000
043.0143	PRESSOSTATO PNEUM.PS1P1091	NR	1,000
043.0186	RACCORDO FEMMINA 1/2 AQUASTOP	NR	1,000
043.0198	ATTACCO A GOMITO GIREV.4X1/4 CL6521	NR	1,000
043.0199	ATTACCO A GOMITO GIREV.4X1/8 CL6521	NR	2,000
043.0204	ATTACCO A GOMITO 8X1/4 - CL 6521	NR	3,000
043.0205	ATTACCO A ESAGONO 8X1/4 - CL 6510	NR	1,000
043.0222	RACCORDO A CROCE CL 2033 1/4	NR	1,000
043.0235	BIFORCAZ. A Y TUBO 4MM. 24275320	NR	2,000
043.0275	NIPPLO CONICO A2-1/4 - CL 2500	NR	1,000
043.0290	INNESTO RAPIDO 1/4 GHIOTTO 13/A	NR	5,000
043.0301	TUBO RILSAN 8X6 NERO COD.17257181	MT	7,800
043.0302	TUBO RILSAN 4X2.7 BIANCO C.17257162	MT	9,200
043.0473	"SILENZIATORE IN OTTONE 1/8"" CL 2921"	NR	4,000
043.0552	MANOMETRO DIAM. 40	NR	1,000
043.0564	FR 1/4 20-08	NR	1,000
043.0601	VALVOLA VMS 114-1/4 08	NR	1,000
043.0608	VALVOLA 5 VIE 1/8 PVLB111618 PARKER	NR	2,000

Cilindergroep

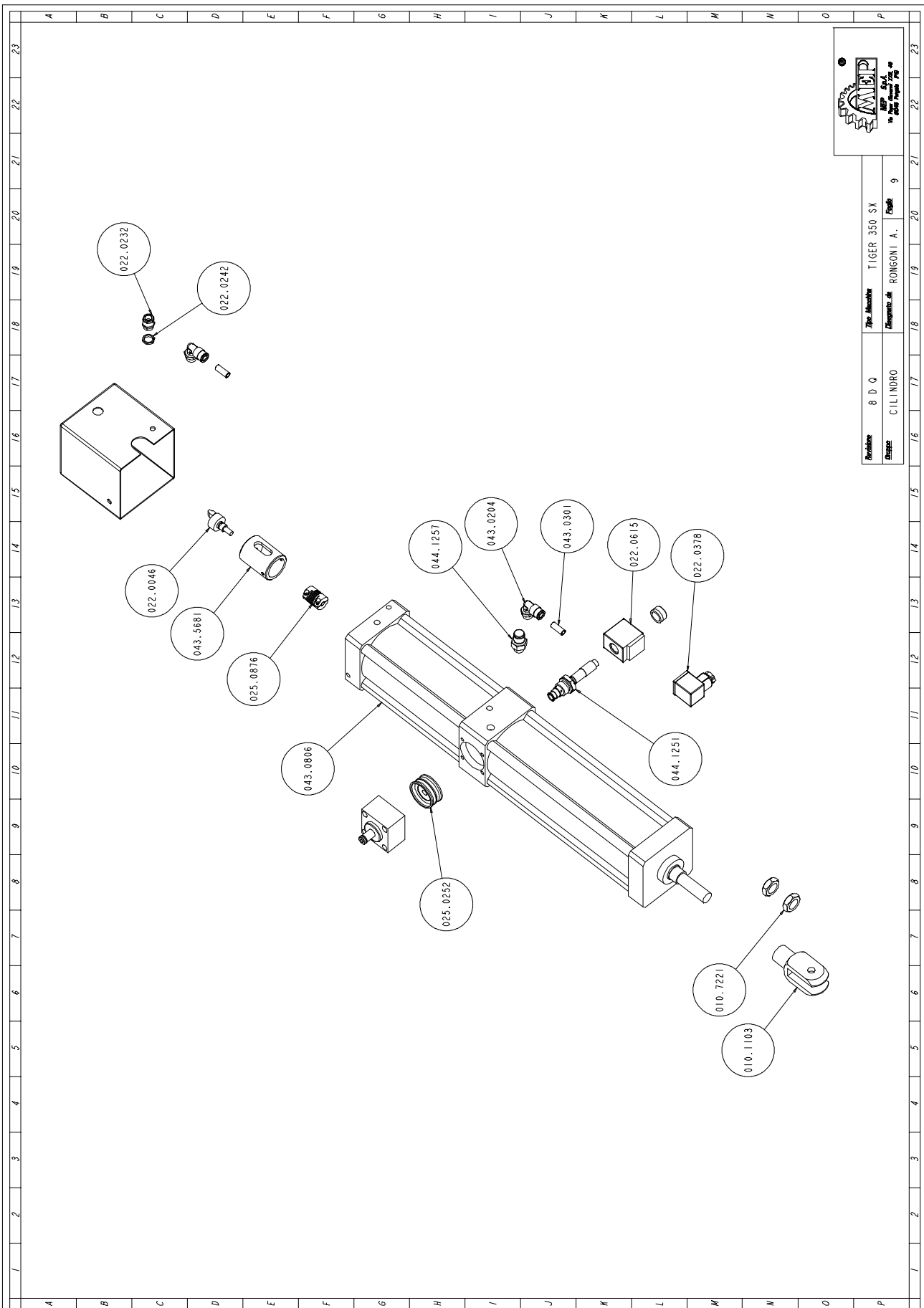

Revisie	8 D Q	Tipe. Macchin	TIGER 350 SX
Disegn	CILINDRO	Elemento Nr	RONGONI A. Page 9

Art. Nr.	Benaming	M.	Hoeveelheid
010.1103	FORCELLA 16 X 1,5	NR	1,000
010.7221	DADO M16 BASSO	NR	2,000
022.0046	POTENZIOMETRO 6639S-001-202	NR	1,000
022.0232	PRESSACAVO IN OTTONE 1/4 BM 2450	NR	1,000
022.0242	DADO IN OTTONE BM 2460 1/4	NR	1,000
022.0378	CONNETT.BOBINA VALV. RIGENERATRICE	NR	1,000
022.0615	BOBINA X VALVOLA RIGENERATRICE CIL.	NR	1,000
025.0252	ANELLO DK 40X8X20/4 PDF	NR	1,000
025.0876	GIUNTO WA 6-6 MM.28 X CILINDRO	NR	1,000
043.0204	ATTACCO A GOMITO 8X1/4 - CL 6521	NR	2,000
043.0301	TUBO RILSAN 8X6 NERO COD.17257181	MT	2,000
043.0806	UNITA' OLEOPNEUMATICA 0 63 C.180	NR	1,000
043.5681	SUPPORTO POTENZIOMETRO CILINDRO	NR	1,000
044.1251	VALVOLA RIGENERATRICE CILINDRO	NR	1,000
044.1257	VALVOLA DI CARICO CILINDRO	NR	1,000

Bedieningspaneel

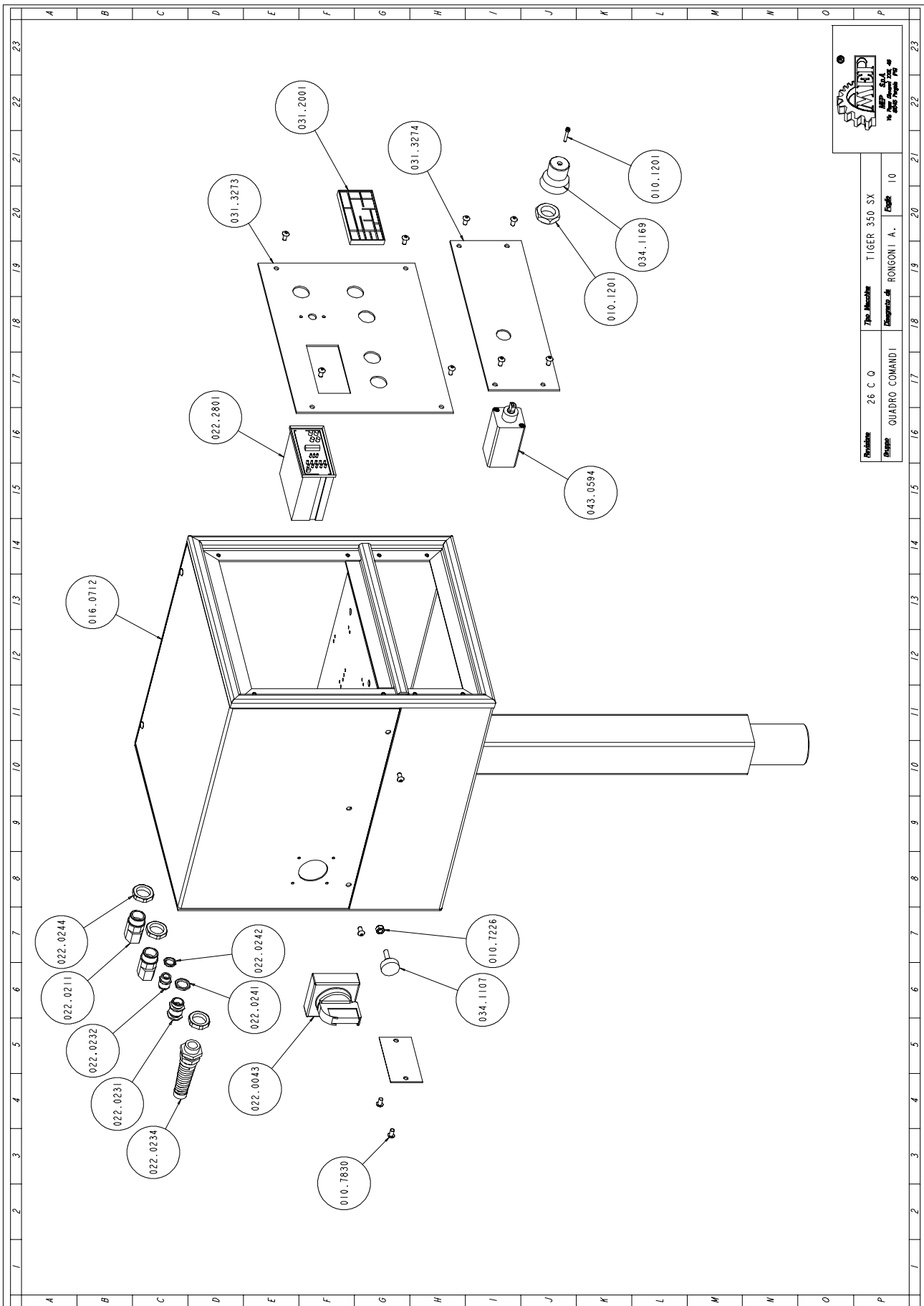

Art. Nr.	Benaming	M.	Hoeveelheid
010.1201	VITERIA E BULLONERIA	NR	2,000
010.7226	DADO AUTOBLOCCANTE M6	NR	1,000
010.7830	VITE BUTON 5 X 10	NR	1,400
016.0712	QUADRO COMANDI TI 350 SX N.T.	NR	1,000
022.0043	MANIGLIA ROSSA RH-PKZ0 + PROLUNGA	NR	1,000
022.0211	RACCORDO RAPIDO SEM PG 13,5	NR	2,000
022.0231	PRESSACAVO IN OTTONE 3/8 BM 2451	NR	1,000
022.0232	PRESSACAVO IN OTTONE 1/4 BM 2450	NR	1,000
022.0234	PRESSACORDONE 3246 NERO PG 13,5	NR	1,000
022.0241	DADO IN OTTONE BM 2461 3/8	NR	1,000
022.0242	DADO IN OTTONE BM 2460 1/4	NR	1,000
022.0244	CONTRODADO 3217B GRIGIO PG 13	NR	3,000
022.2801	CONTROLLORE MEP 11/C	NR	1,000
031.2001	TASTIERA MEP 11	NR	1,000
031.3273	PANNELLO COMANDI SUPERIORE	NR	1,000
031.3274	PANNELLO COMANDI INFERIORE	NR	1,000
034.1107	VOLANTINO DIAM.30 M6 X 20	NR	1,000
034.1169	MANOPOLA REGOLAZIONE MONOGIRO	NR	1,000
043.0594	REGOL.IDRAULICO MONOGIRO UNIDIREZ.	NR	1,000